



# Product Overview

# PRODUCT OVERVIEW 2023



## WE CARE TO CONNECT

---

### 1. Pipes

	<b>6</b>
A. STANDARD (PE-XC/AL/PE-XC)	7
B. RIXC (PE-XC/AL/PE-XC)	14
C. FLOOR-RIXC (PE-XC/AL/PE-XC)	19
D. PE-XC	20
E. PE-RT	21
F. PROTECTION HOSE	22
G. GAS STANDARD (PE-XC/AL/PE-XC)	23
H. SPRINKLER STANDARD (PE-XC/AL/PE-XC)	24

---

### 2. Henco Press

	<b>25</b>
A. HENCO PRESS PK	26
B. HENCO PRESS WHITE PKW	38
C. HENCO PRESS GAS PKG	46
D. HENCO PRESS SUPERSIZES	51
E. HENCO ECOLINE	62

---

<b>3. Henco Vision</b>	<b>63</b>
A. VISION FITTINGS	64
B. MANIFOLDS	70
<b>4. Brass Press Fittings</b>	<b>71</b>
A. PRESS FITTINGS	72
B. PRESS FITTINGS GAS	86
<b>5. Brass Compression Fittings</b>	<b>91</b>
<b>6. Manifolds</b>	<b>98</b>
A. FULL FLOW MANIFOLD	99
B. BRASS MANIFOLDS	104
<b>7. Valves</b>	<b>108</b>
A. INOX VALVES	109
B. BRASS VALVES	110
<b>8. Underfloor Heatings</b>	<b>112</b>
A. SYSTEMS	113
B. MANIFOLDS	120
C. HENCOLOGIC WIRED	129
D. HENCOLOGIC WIRELESS	132
<b>9. Underfloor Heating Cabinets</b>	<b>135</b>
<b>10. Tools</b>	<b>137</b>
A. BENDING TOOLS	138
B. CUTTING TOOLS	139
C. CALIBRATION TOOLS	141
D. PRESSING TOOLS	143
E. UNDERFLOOR HEATING TOOLS	156
<b>11. Accessoires</b>	<b>157</b>
<b>12. Henco Sprinkler</b>	<b>161</b>
A. SPRINKLER STANDARD (PE-XC/AL/PE-XC)	162
B. HENCO PRESS SPRINKLER	163
C. HENCO PRO-SPRINKLER	169
D. SPRINKLER TOOLS	173
<b>Certificates</b>	<b>174</b>
<b>Index</b>	<b>176</b>

# ABOUT HENCO & SUSTAINABILITY



## Sustainability, also our concern

Sustainability is an important concept at Henco. Apart from offering sustainable solutions, such as underfloor heating, we also want to operate sustainably as a company. This implies taking the 3 P's into account: people, planet and profit.

To us, corporate sustainability means paying attention to these three pillars by taking a variety of actions internally. For instance, it is important to deal sustainably with internal employees, to conduct a correct environmental policy and to use our profits wisely.

Henco products enable the following Sustainable Development Goals:



Henco is committed to be net zero carbon by 2050. Therefore, we measure, manage and monitor both our energy consumption and our CO<sub>2</sub> emissions. It is Henco's objective to decrease its CO<sub>2</sub> intensity for scope 1 and 2 with 70% by 2030, taking 2019 as a base year,

	Focus	Projects	2026	2030	Net zero carbon 2050
Scope 1 + 2	Energy use (in CO <sub>2</sub> intensity)	<ul style="list-style-type: none"> <li>• Drive energy efficiency</li> <li>• Use renewable energy</li> </ul>	Target 30% versus 2019	Target 70% versus 2019	
Scope 3	Raw materials, waste, travel, transport, end of life	<ul style="list-style-type: none"> <li>• Reduce, reuse, recycle</li> <li>• Travel consciously</li> <li>• Perform life cycle and circular design assessments</li> </ul>	Target 10% versus 2019	Target 23% versus 2019	



### ISO14001 certified

All the effort we put into environmental matters resulted in Henco getting through the certification audits for ISO14001. After 3 days of audits on various business processes, we achieved a very positive audit result without any recorded remarks. The auditor praised, among other things, the enthusiasm of our employees and the broad demonstration of sustainability throughout our processes.



### A silver medal from Ecovadis

The online platform Ecovadis rates companies on their Corporate Social Responsibility (CSR) performance. They look at various issues such as environmental efforts, human and labour rights, sustainable procurement and business ethics. Henco's efforts in these areas were rewarded with a silver Ecovadis medal. As Henco puts its money where its mouth is, Ecovadis places Henco among the 19% best scoring companies. And we are quite proud of that



### Aalberts Sustainability Award 2021

Aalberts also saw that we at Henco value sustainability and that we show this through all our actions. In 2022 we were very pleased to accept the Aalberts sustainability awards 2021.



### The VOKA sustainability charter: SDG pioneers

The VOKA sustainability charter was achieved by Henco for the 3rd year in a row. With this, we have officially been appointed as SDG pioneers. Sustainability is held in high esteem at Henco, this certificate proves it and we are proud of it.



### Environmental and health statement Cochebat

The French HVAC association Cochebat has tested and approved our Henco multilayer pipes and we were rewarded with inclusion in their Environmental and Health Statement.



### Interseroh Certificate Resources Saved

In 2020 and 2021 Henco received the Interseroh Certificate for Resources Saved in Germany. By recycling materials in 2021, a calculated 42,269 kilograms of resources and, in addition to this, 5,521 kilograms of greenhouse gases were saved.



### Valobat

Henco joined Valobat voluntarily in 2023. Valobat is a French eco-organization for the building industry approved by the public authorities, offering services to accelerate the circular economy in the building industry.



	<i>Page</i>
<b>STANDARD (PE-Xc/AL/PE-Xc)</b>	<b>7</b>
<b>RIXc (PE-Xc/AL/PE-Xc)</b>	<b>14</b>
<b>FLOOR-RIXc (PE-Xc/AL/PE-Xc)</b>	<b>19</b>
<b>PE-Xc</b>	<b>20</b>
<b>PE-RT</b>	<b>21</b>
<b>PROTECTION HOSE</b>	<b>22</b>
<b>GAS STANDARD (PE-Xc/AL/PE-Xc)</b>	<b>23</b>
<b>SPRINKLER STANDARD (PE-Xc/AL/PE-Xc)</b>	<b>24</b>



## Maximum working pressure (bar) for the different pipe types and diameters

Diameter (mm)	12	14	16	16	18	18	20	20	26	26	32	40	50	63	75	90
Pipe type	STA	STA	STA	RIXC	STA	RIXC	STA	RIXC	STA	RIXC	STA	STA	STA	STA	STA	STA
Max working pressure (bar)	6	10	16	10	10	10	16	10	16	10	16	10	10	10	10	10

## Type: COIL STANDARD



Henco multilayer pipe Standard (Coil)

Henco meerlagenbuis Standard (Rol)

Henco tube multicouche Standard (Rouleau)

Henco Mehrschichtverbundrohr Standard (Rohr)

Article number	Coil / Pallet	Type	Pallet dimension (mm)
100-121688*	100 m / 2200 m	12x1,6	800x800
200-121688*	200 m / 3000 m	12x1,6	800x800
100-140210	100 m / 2200 m	14x2	800x800
200-140210	200 m / 3000 m	14x2	800x800
50-160212	50 m / 1500 m	16x2	1200x800
100-160212	100 m / 2200 m	16x2	800x800
200-160212	200 m / 2600 m	16x2	800x800
500-160212D	500 m / 2500 m	16x2	800x800
100-180214	100 m / 1700 m	18x2	800x800
200-180214	200 m / 2000 m	18x2	800x800
25-200216	25 m / 800 m	20x2	1200x800
50-200216	50 m / 1000 m	20x2	1200x800
100-200216	100 m / 1500 m	20x2	800x800
50-260320	50 m / 800 m	26x3	800x800
50-320326	50 m / 650 m	32x3	900x900

\*6 bar - 60°C

## Type: COIL CSC



Henco multilayer pipe Standard (Coil with small core)

Henco meerlagenbuis Standard (Rol kleine kern)

Henco tube multicouche Standard (Petit rouleau noyau intérieure)

Henco Mehrschichtverbundrohr Standard (Rohr kleinen Kern)

Article number	Coil / Pallet	Type	Pallet dimension (mm)
10-160212-KB	10 m / 800 m	16x2	1200x800
25-160212-KB	25 m / 1125 m	16x2	1200x800
25-200216-KB	25 m / 900 m	20x2	1200x800

internal diameter coil 28cm



# Henco Pipes

STANDARD (PE-Xc/AL/PE-Xc)

## 1 Type: STRAIGHT LENGTH



**Henco multilayer pipe Standard (Straight length)**

**Henco meerlagenbuis (Stang)**

**Henco tube multicouche Standard (Barre)**

**Henco Mehrschichtverbundrohr (Stange)**

Article number	Cylinder / Pallet	Type	Floor space (mm)
03-160212	75 m / 3600 m	16x2	4000x705
04-160212	100 m / 4800 m	16x2	4100x705
05-160212	125 m / 6000 m	16x2	5100x705
03-180214	60 m / 2880 m	18x2	4000x705
05-180214	100 m / 4800 m	18x2	5100x705
03-200216	54 m / 2592 m	20x2	4000x705
04-200216	72 m / 3456 m	20x2	4100x705
05-200216	90 m / 4320 m	20x2	5100x705
03-260320	30 m / 1440 m	26x3	4000x705
04-260320	40 m / 1920 m	26x3	4100x705
05-260320	50 m / 2400 m	26x3	5100x705
03-320326	21 m / 1008 m	32x3	4000x705
04-320326	28 m / 1344 m	32x3	4100x705
05-320326	35 m / 1680 m	32x3	5100x705
03-403533	27 m / 648 m	40x3,5	4000x705
04-403533	36 m / 864 m	40x3,5	4100x705
05-403533	45 m / 1080 m	40x3,5	5100x705
03-504042	21 m / 504 m	50x4	4000x705
04-504042	28 m / 672 m	50x4	4100x705
05-504042	35 m / 840 m	50x4	5100x705
03-634554	12 m / 288 m	63x4,5	4000x705
04-634554	16 m / 384 m	63x4,5	4100x705
05-634554	20 m / 480 m	63x4,5	5100x705
05-756063	10 m / 240 m	75x6	5100x705
05-907076	5 m / 240 m	90x7	5100x705

## Type: ISO4 (6 mm) Fireclass: CL, s1-d0



**Henco tube pre-insulated Standard (6mm)**

**Henco voorgeïsoleerde buis Standard (6mm)**

**Henco tube pré-isolé Standard (6mm)**

**Henco Rohr Isoliert Standard (6mm)**

Article number	Coil / Pallet	Type	Pallet dimension (mm)
100-ISO4-14-RO	100 m / 1000 m	14x2 red	800x800
100-ISO4-14-BL	100 m / 1000 m	14x2 blue	800x800
50-ISO4-16-RO	50 m / 900 m	16x2 red	800x800
50-ISO4-16-BL	50 m / 900 m	16x2 blue	800x800
100-ISO4-16-RO	100 m / 900 m	16x2 red	800x800
100-ISO4-16-BL	100 m / 900 m	16x2 blue	800x800
50-ISO4-18-RO	50 m / 650 m	18x2 red	800x800
50-ISO4-18-BL	50 m / 650 m	18x2 blue	800x800
50-ISO4-20-RO	50 m / 700 m	20x2 red	800x800
50-ISO4-20-BL	50 m / 700 m	20x2 blue	800x800
100-ISO4-20-RO	100 m / 1100 m	20x2 red	800x800
100-ISO4-20-BL	100 m / 900 m	20x2 blue	800x800
25-ISO4-26-RO	25 m / 400 m	26x3 red	800x800
25-ISO4-26-BL	25 m / 400 m	26x3 blue	800x800
50-ISO4-26-RO	50 m / 500 m	26x3 red	800x800
50-ISO4-26-BL	50 m / 500 m	26x3 blue	800x800
25-ISO4-32-RO	25 m / 300 m	32x3 red	800x800
25-ISO4-32-BL	25 m / 300 m	32x3 blue	800x800
50-ISO4-32-RO	50 m / 300 m	32x3 red	800x800
50-ISO4-32-BL	50 m / 300 m	32x3 blue	800x800





**Did you know** that you can use the hand-tearable repair tape to almost invisibly repair the Henco pre-insulated pipes?

> Find more information on **p. 160**

1

2

3

4

5

6

7

8

9

10

11

12

**Type: ISO4 BSD (6 mm) Fireclass: BL, s1-d0**

**NEW**  
PRODUCT



**Henco tube pre-insulated Standard (6mm) - Improved fire class**  
**Henco voorgeïsoleerde buis Standard (6mm) - verbeterde brandklasse**  
**Henco tube pré-isolé Standard (6mm) - meilleur classement au feu**  
**Henco Rohr Isoliert Standard (6mm) - Verbesserte Brandklasse**

Article number	Coil / Pallet	Type	Pallet dimension (mm)
100-ISO4-14-BL-BSD	100 m / 1000 m	14x2 blue	800x800
100-ISO4-14-RO-BSD	100 m / 1000 m	14x2 red	800x800
50-ISO4-16-BL-BSD	50 m / 800 m	16x2 blue	800x800
50-ISO4-16-RO-BSD	50 m / 900 m	16x2 red	800x800
100-ISO4-16-BL-BSD	100 m / 900 m	16x2 blue	800x800
100-ISO4-16-RO-BSD	100 m / 900 m	16x2 red	800x800
50-ISO4-18-BL-BSD	50 m / 650 m	18x2 blue	800x800
50-ISO4-18-RO-BSD	50 m / 650 m	18x2 red	800x800
50-ISO4-20-BL-BSD	50 m / 700 m	20x2 blue	800x800
50-ISO4-20-RO-BSD	50 m / 700 m	20x2 red	800x800
100-ISO4-20-BL-BSD	100 m / 900 m	20x2 blue	800x800
100-ISO4-20-RO-BSD	100 m / 1100 m	20x2 red	800x800
25-ISO4-26-BL-BSD	25 m / 400 m	26x3 blue	800x800
25-ISO4-26-RO-BSD	25 m / 400 m	26x3 red	800x800
50-ISO4-26-BL-BSD	50 m / 500 m	26x3 blue	800x800
50-ISO4-26-RO-BSD	50 m / 500 m	26x3 red	800x800
25-ISO4-32-BL-BSD	25 m / 300 m	32x3 blue	800x800
25-ISO4-32-RO-BSD	25 m / 300 m	32x3 red	800x800
50-ISO4-32-BL-BSD	50 m / 300 m	32x3 blue	800x800
50-ISO4-32-RO-BSD	50 m / 300 m	32x3 red	800x800

**Type: ISO9 (10 mm) Fireclass: CL, s1-d0**



**Henco tube pre-insulated Standard (10mm)**  
**Henco voorgeïsoleerde buis Standard (10mm)**  
**Henco tube pré-isolé Standard (10mm)**  
**Henco Rohr Isoliert Standard (10mm)**

Article number	Coil / Pallet	Type	Pallet dimension (mm)
50-ISO9-14-RO	50 m / 550 m	14x2 red	800x800
50-ISO9-14-BL	50 m / 550 m	14x2 blue	800x800
50-ISO9-16-RO	50 m / 600 m	16x2 red	800x800
50-ISO9-16-BL	50 m / 600 m	16x2 blue	800x800
50-ISO9-18-RO	50 m / 500 m	18x2 red	800x800
50-ISO9-18-BL	50 m / 500 m	18x2 blue	800x800
50-ISO9-20-RO	50 m / 400 m	20x2 red	800x800



# Henco Pipes

STANDARD (PE-Xc/AL/PE-Xc)

## 1 Type: ISO9 (10 mm) Fireclass: CL, s1-d0



Article number	Coil / Pallet	Type	Pallet dimension (mm)
50-ISO9-20-BL	50 m / 400 m	20x2 blue	800x800
25-ISO9-26-RO	25 m / 275 m	26x3 red	800x800
25-ISO9-26-BL	25 m / 325 m	26x3 blue	800x800
50-ISO9-26-RO	50 m / 450 m	26x3 red	800x800
50-ISO9-26-BL	50 m / 450 m	26x3 blue	800x800
25-ISO9-32-RO	25 m / 250 m	32x3 red	800x800
25-ISO9-32-BL	25 m / 250 m	32x3 blue	800x800
50-ISO9-32-RO	50 m / 250 m	32x3 red	800x800
50-ISO9-32-BL	50 m / 250 m	32x3 blue	800x800

## 8 Type: ISO9 BSD (10 mm) Fireclass: BL, s1-d0



Henco tube pre-insulated Standard (10mm) - Improved fire class  
 Henco voorgeïsoleerde buis Standard (10mm) - verbeterde brandklasse  
 Henco tube pré-isolé Standard (10mm) - meilleur classement au feu  
 Henco Rohr Isoliert Standard (10mm) - Verbesserte Brandklasse

Article number	Coil / Pallet	Type	Pallet dimension (mm)
50-ISO9-14-BL-BSD	50 m / 550 m	14x2 blue	800x800
50-ISO9-14-RO-BSD	50 m / 550 m	14x2 red	800x800
50-ISO9-16-BL-BSD	50 m / 600 m	16x2 blue	800x800
50-ISO9-16-RO-BSD	50 m / 600 m	16x2 red	800x800
50-ISO9-18-BL-BSD	50 m / 500 m	18x2 blue	800x800
50-ISO9-18-RO-BSD	50 m / 500 m	18x2 red	800x800
50-ISO9-20-BL-BSD	50 m / 400 m	20x2 blue	800x800
50-ISO9-20-RO-BSD	50 m / 400 m	20x2 red	800x800
25-ISO9-26-BL-BSD	25 m / 325 m	26x3 blue	800x800
25-ISO9-26-RO-BSD	25 m / 275 m	26x3 red	800x800
50-ISO9-26-BL-BSD	50 m / 450 m	26x3 blue	800x800
50-ISO9-26-RO-BSD	50 m / 450 m	26x3 red	800x800
25-ISO9-32-BL-BSD	25 m / 250 m	32x3 blue	800x800
25-ISO9-32-RO-BSD	25 m / 250 m	32x3 red	800x800
50-ISO9-32-BL-BSD	50 m / 250 m	32x3 blue	800x800
50-ISO9-32-RO-BSD	50 m / 350 m	32x3 red	800x800

## 10 Type: ISO13 (13 mm) Fireclass: CL, s1-d0



Henco tube pre-insulated Standard (13mm)  
 Henco voorgeïsoleerde buis Standard (13mm)  
 Henco tube pré-isolé Standard (13mm)  
 Henco Rohr Isoliert Standard (13mm)

Article number	Coil / Pallet	Type	Pallet dimension (mm)
50-ISO13-16-BL	50 m / 400 m	16x2 blue	800x800
50-ISO13-16-RO	50 m / 400 m	16x2 red	800x800
50-ISO13-18-BL*	50 m / 450 m	18x2 blue	800x800
50-ISO13-20-BL	50 m / 400 m	20x2 blue	800x800
50-ISO13-20-RO	50 m / 400 m	20x2 red	800x800
50-ISO13-26-BL	50 m / 300 m	26x3 blue	800x800
50-ISO13-26-RO	50 m / 300 m	26x3 red	800x800
25-ISO13-32-BL	25 m / 225 m	32x3 blue	800x800
25-ISO13-32-RO	25 m / 225 m	32x3 red	800x800

\*TILL EXHAUSTION OF STOCK



**Did you know** that you can use the hand-tearable repair tape to almost invisibly repair the Henco pre-insulated pipes?

> Find more information on **p. 160**

## Type: ISO13 BSD (13 mm) Fireclass: BL, s1-d0

NEW\*  
PRODUCT



Henco tube pre-insulated Standard (13mm) - Improved fire class  
 Henco voorgeïsoleerde buis Standard (13mm) - verbeterde brandklasse  
 Henco tube pré-isolé Standard (13mm) - meilleur classement au feu  
 Henco Rohr Isoliert Standard (13mm) - Verbesserte Brandklasse

Article number	Coil / Pallet	Type	Pallet dimension (mm)
50-ISO13-16-BL-BSD	50 m / 400 m	16x2 blue	800x800
50-ISO13-16-RO-BSD	50 m / 400 m	16x2 red	800x800
50-ISO13-18-BL-BSD	50 m / 450 m	18x2 blue	800x800
50-ISO13-18-RO-BSD	50 m / 450 m	18x2 red	800x800
50-ISO13-20-BL-BSD	50 m / 400 m	20x2 blue	800x800
50-ISO13-20-RO-BSD	50 m / 400 m	20x2 red	800x800
50-ISO13-26-BL-BSD	50 m / 300 m	26x3 blue	800x800
50-ISO13-26-RO-BSD	50 m / 300 m	26x3 red	800x800
25-ISO13-32-BL-BSD	25 m / 200 m	32x3 blue	800x800
25-ISO13-32-RO-BSD	25 m / 225 m	32x3 red	800x800

## Type: ISO20 BSD (20 mm) Fireclass: BL, s1-d0

NEW\*  
PRODUCT



Henco tube pre-insulated Standard (20mm) - Improved fire class  
 Henco voorgeïsoleerde buis Standard (20mm) - verbeterde brandklasse  
 Henco tube pre-insulated Standard (20mm) - meilleur classement au feu  
 Henco Rohr Isoliert Standard (20mm) - Verbesserte Brandklasse

Article number	Coil / Pallet	Type	Pallet dimension (mm)
25-ISO20-32-BL-BSD	25 m / 150 m	32x3 blue	800x800
25-ISO20-32-RO-BSD	25 m / 150 m	32x3 red	800x800



# Henco Pipes

STANDARD (PE-Xc/AL/PE-Xc)

## 1 Type: STANDARD PIPE IN PIPE



Henco multilayer pipe with colour coded conduit Standard (Coil)  
 Henco meerlagenbuis met mantel Standard (Rol)  
 Henco tube multicouche avec gaine Standard (Rouleau)  
 Henco Mehrschichtverbundrohr mit Mantel Standard (Ring)

Article number	Coil / Pallet	Type	Pallet dimension (mm)
50-014MR	50 m / 800 m	14x2 red	1200x800
50-014MB	50 m / 800 m	14x2 blue	1200x800
25-016MR	25 m / 500 m	16x2 red	1200x800
25-016MB	25 m / 500 m	16x2 blue	1200x800
50-016MR	50 m / 800 m	16x2 red	1200x800
50-016MB	50 m / 800 m	16x2 blue	1200x800
50-016MBLACK	50 m / 800 m	16x2 black	1200x800
100-016MR	100 m / 1000 m	16x2 red	1200x800
100-016MB	100 m / 1000 m	16x2 blue	1200x800
100-016MBLACK	100 m / 1000 m	16x2 black	1200x800
50-018MR	50 m / 800 m	18x2 red	1200x800
50-018MB	50 m / 800 m	18x2 blue	1200x800
100-018MR	100 m / 1000 m	18x2 blue	1200x800
100-018MB	100 m / 1000 m	18x2 blue	1200x800
25-020MR	25 m / 500 m	20x2 red	1200x800
25-020MB	25 m / 500 m	20x2 blue	1200x800
25-020MBLACK	25 m / 500 m	20x2 black	1200x800
50-020MR	50 m / 800 m	20x2 red	1200x800
50-020MB	50 m / 800 m	20x2 blue	1200x800
50-020MBLACK	50 m / 800 m	20x2 black	1200x800
100-020MB	100 m / 1000 m	20x2 blue	1200x800
100-020MR	100 m / 1000 m	20x2 red	1200x800
25-026MR	25 m / 500 m	26x3 blue	1200x800
25-026MB	25 m / 500 m	26x3 blue	1200x800
50-026MR	50 m / 500 m	26x3 blue	1200x800
50-026MB	50 m / 500 m	26x3 blue	1200x800
50-026MBLACK	50 m / 500 m	26x3 black	1200x800
25-032MR	25 m / 300 m	32x3 red	900x900
25-032MB	25 m / 300 m	32x3 blue	900x900

## Type: COMBI STANDARD



Henco Combi Standard (Coil)  
 Henco Combi Standard (Rol)  
 Henco Combi Standard (Rouleau)  
 Henco Combi Standard (Rohr)

Article number	Coil / Pallet	Type	Pallet dimension (mm)
50-COMBI16	50 m / 500 m	16x2	1200x800



## Type: FLEX STANDARD

NEW PRODUCT



Henco Flex (Coil)  
Henco Flex (Rol)  
Henco Flex (Rouleau)  
Henco Flex (Ring)

Article number	Coil / Pallet	Type	Pallet dimension (mm)
5-FLEX32	5 m / 35 m	32x3	1200x1200
10-FLEX32	10 m / 70 m	32x3	1200x1200
15-FLEX32	15 m / 75 m	32x3	1200x1200



**Did you know** you could use the rubber end cap HFMAN125 to provide a watertight seal on the Henco FLEX32 ends?

> Find more information on **p. 160**

## Type: STANDARD PIPE IN PIPE CSC



Henco multilayer pipe with colour coded conduit Standard (Coil small coil)  
Henco meerlagenbuis met mantel Standard (Rol kleine kern)  
Henco tube multicouche avec gaine Standard (Rouleau noyau intérieure)  
Henco Mehrschichtverbundrohr mit Mantel Standard (Ring kleinen Kern)

Article number	Coil / Pallet	Type	Pallet dimension (mm)
25-016MB-KB	25 m / 600 m	16x2 blue	1200x800
25-016MR-KB	25 m / 600 m	16x2 red	1200x800

*internal diameter coil 28cm*

## Type: LB



Carcassing pipe 16mm  
Dubbele radiatorbocht, 16mm, doorverbonden einde  
Double courbe radiateur, 16mm, embout fermé  
Heizkörperwinkel doppelt, 16mm, durchgestellt Ende

Article number	Bag	Type
LB50	1 pc.	Ø16, centre-to-centre = 50mm

## Type: ISO-BLOCK-S

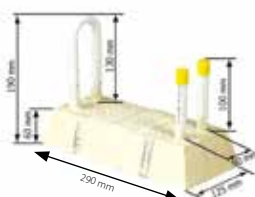

Carcassing pipe 16mm with insulation  
Dubbele radiatorbocht met isolatie, 16mm, doorverbonden einde  
Double courbe radiateur, 16mm, avec isolation, embout fermé  
Heizkörperwinkel doppelt mit Isolation, 16mm, durchgestellt Ende

Article number	Box	Type
ISO-BLOCK-S	50 pc.	Ø16, centre-to-centre = 50mm



# Henco Pipes

RIXc (PE-Xc/AL/PE-Xc)

1

## Maximum working pressure (bar) for the different pipe types and diameters

Diameter (mm)	12	14	16	16	18	18	20	20	26	26	32	40	50	63	75	90
Pipe type	STA	STA	STA	RIXc	STA	RIXc	STA	RIXc	STA	RIXc	STA	STA	STA	STA	STA	STA
Max working pressure (bar)	6	10	16	10	10	10	16	10	16	10	16	10	10	10	10	10

2

3

4

5

### Type: COIL RIXc



- Henco multilayer pipe RIXc (Coil)
- Henco meerlagenbuis RIXc (Rol)
- Henco tube multicouche RIXc (Rouleau)
- Henco Mehrschichtverbundrohr RIXc (Rohr)

Article number	Coil / Pallet	Type	Pallet dimension (mm)
50-R160212	50 m / 1500 m	16x2	1200x800
100-R160212	100 m / 2200 m	16x2	800x800
200-R160212	200 m / 2600 m	16x2	800x800
500-R160212D	500 m / 2500 m	16x2	800x800
100-R180214	100 m / 1700 m	18x2	800x800
200-R180214	200 m / 2000 m	18x2	800x800
50-R200216	50 m / 1000 m	20x2	1200x800
100-R200216	100 m / 1500 m	20x2	800x800
25-R260320		26x3	1200x800
50-R260320	50 m / 800 m	26x3	1200x800

6

7

8

9

10

11

12

### Type: COIL RIXc CSC



- Henco multilayer pipe RIXc (Coil with small core)
- Henco meerlagenbuis RIXc (Rol kleine kern)
- Henco tube multicouche RIXc (Petit rouleau noyau intérieure)
- Henco Mehrschichtverbundrohr RIXc (Rohr kleinen Kern)

Article number	Coil / Pallet	Type	Pallet dimension (mm)
10-R160212-KB	10 m / 800 m	16x2	1200x800
15-R160212-KB	15 m / 900 m	16x2	1200x800
25-R160212-KB	25 m / 1125 m	16x2	1200x800
10-R200216-KB	10 m / 550 m	20x2	1200x800
25-R200216-KB	25 m / 900 m	20x2	1200x800

*internal diameter coil 28cm*

### Type: STRAIGHT LENGTH RIXc



- Henco multilayer pipe RIXc (Straight length)
- Henco meerlagenbuis RIXc (Stang)
- Henco tube multicouche RIXc (Barre)
- Henco Mehrschichtverbundrohr RIXc (Stange)

Article number	Cylinder / Pallet	Type	Floor space (mm)
03-R160212	75 m / 3600 m	16x2	4000x705
04-R160212	100 m / 4800 m	16x2	4100x705
05-R160212	125 m / 6000 m	16x2	5100x705
03-R200216	54 m / 2592 m	20x2	4000x705
04-R200216	72 m / 3456 m	20x2	4100x705
05-R200216	90 m / 4320 m	20x2	5100x705
03-R260320	30 m / 1440 m	26x3	4000x705
04-R260320	40 m / 1920 m	26x3	4100x705
05-R260320	50 m / 2400 m	26x3	5100x705



**Did you know** that you can use the hand-tearable repair tape to almost invisibly repair the Henco pre-insulated pipes?

> Find more information on **p. 160**

**Type: ISO4 (6 mm) RIXc** **Fireclass: CL, s1-d0**



Henco tube pre-insulated RIXc (6mm)  
 Henco voorgeïsoleerde buis RIXc (6mm)  
 Henco tube pré-isolé RIXc (6mm)  
 Henco Rohr Isoliert RIXc (6mm)

Article number	Coil / Pallet	Type	Pallet dimension (mm)
50-ISO4-R16-BL	50 m / 800 m	16x2 blue	800x800
50-ISO4-R16-RO	50 m / 800 m	16x2 red	800x800
100-ISO4-R16-RO	100 m / 900 m	16x2 red	800x800
100-ISO4-R16-BL	100 m / 900 m	16x2 blue	800x800
50-ISO4-R18-RO	50 m / 650 m	18x2 red	800x800
50-ISO4-R18-BL	50 m / 650 m	18x2 blue	800x800
50-ISO4-R20-RO	50 m / 700 m	20x2 red	800x800
50-ISO4-R20-BL	50 m / 700 m	20x2 blue	800x800
25-ISO4-R26-RO	25 m / 300 m	26x3 red	800x800
25-ISO4-R26-BL	25 m / 300 m	26x3 blue	800x800
50-ISO4-R26-RO	50 m / 500 m	26x3 red	800x800
50-ISO4-R26-BL	50 m / 500 m	26x3 blue	800x800

**Type: ISO4 BSD (6 mm) RIXc** **Fireclass: BL, s1-d0**



Henco tube pre-insulated RIXc (6mm) - Improved fire class  
 Henco voorgeïsoleerde buis RIXc (6mm) - verbeterde brandklasse  
 Henco tube pré-isolé RIXc (6mm) - meilleur classement au feu  
 Henco Rohr Isoliert RIXc (6mm) - Verbesserte Brandklasse

Article number	Coil / Pallet	Type	Pallet dimension (mm)
100-ISO4-R16-BL-BSD	100 m / 900 m	16x2 blue	800x800
100-ISO4-R16-RO-BSD	100 m / 900 m	16x2 red	800x800
50-ISO4-R16-BL-BSD	50 m / 900 m	16x2 blue	800x800
50-ISO4-R16-RO-BSD	50 m / 800 m	16x2 red	800x800
25-ISO4-R16-BL-BSD	25 m / 250 m	16x2 blue	800x800
25-ISO4-R16-RO-BSD	25 m / 250 m	16x2 red	800x800
50-ISO4-R18-BL-BSD	50 m / 650 m	18x2 blue	800x800
50-ISO4-R18-RO-BSD	50 m / 650 m	18x2 red	800x800
50-ISO4-R20-BL-BSD	50 m / 700 m	20x2 blue	800x800
50-ISO4-R20-RO-BSD	50 m / 700 m	20x2 red	800x800
50-ISO4-R26-BL-BSD	50 m / 500 m	26x3 blue	800x800
50-ISO4-R26-RO-BSD	50 m / 500 m	26x3 red	800x800
25-ISO4-R26-BL-BSD	25 m / 300 m	26x3 blue	800x800
25-ISO4-R26-RO-BSD	25 m / 300 m	26x3 red	800x800



# Henco Pipes

RIXc (PE-Xc/AL/PE-Xc)

## Type: ISO9 (10 mm) RIXc **Fireclass: CL, s1-d0**



Henco tube pre-insulated RIXc (10mm)  
 Henco voorgeïsoleerde buis RIXc (10mm)  
 Henco tube pré-isolé RIXc (10mm)  
 Henco Rohr Isoliert RIXc (10mm)

Article number	Coil / Pallet	Type	Pallet dimension (mm)
50-ISO9-R16-RO	50 m / 600 m	16x2 red	800x800
50-ISO9-R16-BL	50 m / 600 m	16x2 blue	800x800
50-ISO9-R20-RO	50 m / 400 m	20x2 red	800x800
50-ISO9-R20-BL	50 m / 400 m	20x2 blue	800x800
25-ISO9-R26-RO	25 m / 325 m	26x3 red	800x800
25-ISO9-R26-BL	25 m / 325 m	26x3 blue	800x800
50-ISO9-R26-BL	50 m / 400 m	26x3 blue	800x800
50-ISO9-R26-RO	50 m / 400 m	26x3 red	800x800

## Type: ISO9BSD (10mm) RIXc **Fireclass: BL, s1-d0**



Henco tube pre-insulated RIXc (10mm) - Improved fire class  
 Henco voorgeïsoleerde buis RIXc (10mm) - verbeterde brandklasse  
 Henco tube pré-isolé RIXc (10mm) - meilleur classement au feu  
 Henco Rohr Isoliert RIXc (10mm) - Verbesserte Brandklasse

Article number	Coil / Pallet	Type	Pallet dimension (mm)
50-ISO9-R16-BL-BSD	50 m / 600 m	16x2 blue	800x800
50-ISO9-R16-RO-BSD	50 m / 600 m	16x2 red	800x800
50-ISO9-R20-BL-BSD	50 m / 400 m	20x2 blue	800x800
50-ISO9-R20-RO-BSD	50 m / 400 m	20x2 red	800x800
50-ISO9-R26-BL-BSD	50 m / 400 m	26x3 blue	800x800
50-ISO9-R26-RO-BSD	50 m / 400 m	26x3 red	800x800
25-ISO9-R26-BL-BSD	25 m / 325 m	26x3 blue	800x800
25-ISO9-R26-RO-BSD	25 m / 325 m	26x3 red	800x800

## Type: ISO13 (13 mm) RIXc **Fireclass: CL, s1-d0**



Henco tube pre-insulated RIXc (13mm)  
 Henco voorgeïsoleerde buis RIXc (13mm)  
 Henco tube pré-isolé RIXc (13mm)  
 Henco Rohr Isoliert RIXc (13mm)

Article number	Coil / Pallet	Type	Pallet dimension (mm)
50-ISO13-R16-BL	50 m / 400 m	16x2 blue	800x800
50-ISO13-R16-RO	50 m / 400 m	16x2 red	800x800
50-ISO13-R20-BL	50 m / 400 m	20x2 blue	800x800
50-ISO13-R20-RO	50 m / 400 m	20x2 red	800x800
50-ISO13-R26-BL	50 m / 300 m	26x3 blue	800x800
50-ISO13-R26-RO	50 m / 300 m	26x3 red	800x800





**Did you know** that you can use the hand-tearable repair tape to almost invisibly repair the Henco pre-insulated pipes?

> Find more information on **p. 160**

1

2

3

4

5

6

7

8

9

10

11

12

## Type: ISO13BSD (13mm) RIXc **Fireclass: BL, s1-d0**



Henco tube pre-insulated RIXc (13mm) - Improved fire class  
 Henco voorgeïsoleerde buis RIXc (13mm) - verbeterde brandklasse  
 Henco tube pré-isolé RIXc (13mm) - meilleur classement au feu  
 Henco Rohr Isoliert RIXc (13mm) - Verbesserte Brandklasse

Article number	Coil / Pallet	Type	Pallet dimension (mm)
50-ISO13-R16-BL-BSD	50 m / 400 m	16x2 blue	800x800
50-ISO13-R16-RO-BSD	50 m / 400 m	16x2 red	800x800
50-ISO13-R20-BL-BSD	50 m / 400 m	20x2 blue	800x800
50-ISO13-R20-RO-BSD	50 m / 400 m	20x2 red	800x800
50-ISO13-R26-BL-BSD	50 m / 300 m	26x3 blue	800x800
50-ISO13-R26-RO-BSD	50 m / 300 m	26x3 red	800x800

## Type: ISO20 (20mm) RIXc **Fireclass: CL, s1-d0**



Henco tube pre-insulated RIXc (20mm)  
 Henco voorgeïsoleerde buis RIXc (20mm)  
 Henco tube pre-insulated RIXc (20mm)  
 Henco Rohr Isoliert RIXc (20mm)

Article number	Coil / Pallet	Type	Pallet dimension (mm)
50-ISO20-R16-RO	50 m / 250 m	16x2 red	800x800
50-ISO20-R16-BL	50 m / 250 m	16x2 blue	800x800
50-ISO20-R20-RO	50 m / 250 m	20x2 red	800x800
50-ISO20-R20-BL	50 m / 250 m	20x2 blue	800x800
25-ISO20-R26-RO	25 m / 175 m	26x3 red	800x800
25-ISO20-R26-BL	25 m / 175 m	26x3 blue	800x800

## Type: ISO20BSD (20mm) RIXc **Fireclass: BL, s1-d0**



Henco tube pre-insulated RIXc (20mm) - Improved fire class  
 Henco voorgeïsoleerde buis RIXc (20mm) - verbeterde brandklasse  
 Henco tube pre-insulated RIXc (20mm) - meilleur classement au feu  
 Henco Rohr Isoliert RIXc (20mm) - Verbesserte Brandklasse

Article number	Coil / Pallet	Type	Pallet dimension (mm)
50-ISO20-R16-BL-BSD	50 m / 250 m	16x2 blue	800x800
50-ISO20-R16-RO-BSD	50 m / 250 m	16x2 red	800x800
50-ISO20-R20-BL-BSD	50 m / 250 m	20x2 blue	800x800
50-ISO20-R20-RO-BSD	50 m / 250 m	20x2 red	800x800
25-ISO20-R26-BL-BSD	25 m / 175 m	26x3 blue	800x800
25-ISO20-R26-RO-BSD	25 m / 175 m	26x3 red	800x800



# Henco Pipes

RIXc (PE-Xc/AL/PE-Xc)

- 1
- 2
- 3
- 4
- 5
- 6
- 7
- 8
- 9
- 10
- 11
- 12

## Type: COMBI ISO4 (6 mm) RIXc Fireclass: CL, s1-d0



Henco Combi ISO RIXc (Coil)  
 Henco Combi ISO RIXc (Rol)  
 Henco Combi ISO RIXc (Rouleau)  
 Henco Combi ISO RIXc (Ring)

Article number	Coil / Pallet	Type	Pallet dimension (mm)
50-ISO4-COMBI16R	50 m / 400 m	16x2	800x800

## Type: RIXc PIPE IN PIPE Fireclass: CL, s1-d0



Henco tube with colour coded conduit RIXc  
 Henco buis met mantel RIXc  
 Henco tube avec gaine RIXc  
 Henco Rohr mit Mantel RIXc

Article number	Coil / Pallet	Type	Pallet dimension (mm)
25-R16MR	25 m / 500 m	16x2 red	1200x800
25-R16MB	25 m / 500 m	16x2 blue	1200x800
50-R16MR	50 m / 1000 m	16x2 red	1200x800
50-R16MB	50 m / 1000 m	16x2 blue	1200x800
50-R16MBLACK	50 m / 1000 m	16x2 black	1200x800
100-R16MR	100 m / 1000 m	16x2 red	1200x800
100-R16MB	100 m / 1000 m	16x2 blue	1200x800
100-R16MBLACK	100 m / 1000 m	16x2 black	1200x800
50-R18MR	50 m / 800 m	18x2 blue	1200x800
50-R18MB	50 m / 800 m	18x2 blue	1200x800
25-R20MR	25 m / 500 m	20x2 red	1200x800
25-R20MB	25 m / 500 m	20x2 blue	1200x800
25-R20MBLACK	25 m / 800 m	20x2 black	1200x800
50-R20MR	50 m / 800 m	20x2 red	1200x800
50-R20MB	50 m / 800 m	20x2 blue	1200x800
100-R20MR	100 m / 1000 m	20x2 red	1200x800
100-R20MB	100 m / 1000 m	20x2 blue	1200x800
50-R26MR	50 m / 500 m	26x3 blue	1200x800
50-R26MB	50 m / 500 m	26x3 blue	1200x800

## Type: COMBI RIXc Fireclass: CL, s1-d0



Henco Combi RIXc (Coil)  
 Henco Combi RIXc (Rol)  
 Henco Combi RIXc (Rouleau)  
 Henco Combi RIXc (Rohr)

Article number	Coil / Pallet	Type	Pallet dimension (mm)
50-COMBI16R	50 m / 500 m	16x2	1200x800



## Type: FLOOR-RIXc



Henco multilayer pipe (Coil)  
 Henco meerlagenbuis (Rol)  
 Henco tube multicouche (Rouleau)  
 Henco Mehrschichtverbundrohr (Ring)

Article number	Coil / Pallet	Type	Pallet dimension (mm)
100-F16R-WZ	100 m / 2200 m	16x2	800x800
200-F16R-WZ	200 m / 2600 m	16x2	800x800
500-F16R-WZ	500 m / 1500 m	16x2	800x800
100-F20R-WZ	100 m / 1000 m	20x2	800x800
400-F20R-WZ*	400 m / 1200 m	20x2	800x800

6 bar - 60°C

*\*TILL EXHAUSTION OF STOCK*

1

2

3

4

5

6

7

8

9

10

11

12



# Henco Pipes

PE-Xc

## 1 Type: 5L PE-Xc



- Henco 5L PE-Xc pipe PE-Xc/EVOH/PE-Xc (Coil)
- Henco 5L PE-Xc buis PE-Xc/EVOH/PE-Xc (Rol)
- Henco 5L PE-Xc tube PE-Xc/EVOH/PE-Xc (Rouleau)
- Henco 5L PE-Xc Rohr PE-Xc/EVOH/PE-Xc (Ring)

Article number	Coil / Pallet	Type	Pallet dimension (mm)
200-PXC1620	200 m / 1600 m	16x2	800x800
600-PXC1620	600 m / 2400 m	16x2	800x800
200-PXC1720	200 m / 2000 m	17x2	800x800
600-PXC1720	600 m / 2400 m	17x2	800x800
240-PXC1820	240 m / 2160 m	18x2	800x800
200-PXC2020	200 m / 1000 m	20x2	800x800
600-PXC2020	600 m / 1200 m	20x2	800x800



## Type: 5L PE-RT



Henco 5L PE-RT pipe PE-RT/EVOH/PE-RT (Coil)

Henco 5L PE-RT pipe PE-RT/EVOH/PE-RT (Rol)

Henco 5L PE-RT pipe PE-RT/EVOH/PE-RT (Rouleau)

Henco 5L PE-RT pipe PE-RT/EVOH/PE-RT (Ring)

Article number	Coil / Pallet	Type	Pallet dimension (mm)
600-PRT1420	600 m / 2400 m	14x2	800x800
120-PRT1620	120 m / 1440 m	16x2	800x800
200-PRT1620	800 m / 800 m	16x2	800x800
600-PRT1620	600 m / 2400 m	16x2	800x800
600-PRT1720	600 m / 2400 m	17x2	800x800
240-PRT1820	240 m / 1440 m	18x2	800x800
600-PRT1820	600 m / 1800 m	18x2	800x800
600-PRT2020	600 m / 1800 m	20x2	800x800

1

2

3

4

5

6

7

8

9

10

11

12



# Henco Pipes

PROTECTION HOSE

1

## Type: PROTECTION HOSE



Henco colour coded conduit (Coil)

Henco mantel (Rol)

Henco gaine (Rouleau)

Henco Mantel (Ring)

Article number	Coil / Pallet	Type	Pallet dimension (mm)
100-MR	100 m / 2400 m	Ø14/Ø16/Ø18 red	1200x800
100-MB	100 m / 2400 m	Ø14/Ø16/Ø18 blue	1200x800
100-MBLACK	100 m / 2400 m	Ø14/Ø16/Ø18 black	1200x800
50-MR20	50 m / 1800 m	Ø20 red	1200x800
50-MB20	50 m / 1800 m	Ø20 blue	1200x800
50-MBLACK20	50 m / 1800 m	Ø20 black	1200x800
50-MR26	50 m / 1200 m	Ø26 red	1200x800
50-MB26	50 m / 1200 m	Ø26 blue	1200x800
50-MBLACK26	50 m / 1200 m	Ø26 black	1200x800
25-MR32	25 m / 500 m	Ø32 red	1200x800
25-MB32	25 m / 500 m	Ø32 blue	1200x800

10

11

## Type: PROTECTION HOSE GAS

12



Colour coded conduit GAS (Coil)

Mantel GAS (Rol)

Gaine GAS (Rouleau)

Mantel GAS (Ring)

Article number	Coil / Pallet	Type	Pallet dimension (mm)
50-MG16	50 m / 2400 m	Ø16 yellow	1200x800
100-MG16	100 m / 2400 m	Ø16 yellow	1200x800
50-MG20	50 m / 1800 m	Ø20 yellow	1200x800
50-MG26	50 m / 1200 m	Ø26 yellow	1200x800
25-MG32	25 m / 500 m	Ø32 yellow	1200x800



*Gas: only allowed in countries where a HENCO GAS testing + certificate is available! (see [www.henco.be](http://www.henco.be))*  
*Gas: enkel toegelaten in landen waar er een HENCO GAS keur is + een certificaat voorhanden is! (zie [www.henco.be](http://www.henco.be))*  
*Gaz: seulement permis dans des pays où le contrôle a eu lieu + certificat est disponible! (Consultez [www.henco.be](http://www.henco.be))*  
*Gas: nur zugelassen in Länder wo HENCO GAS Prüfung geschehen ist + Zertifikat vorhanden ist! (Siehe [www.henco.be](http://www.henco.be))*

## Type: COIL GAS



Henco multilayer pipe GAS (Coil)  
 Henco meerlagenbuis GAS (Rol)  
 Henco tube multicouche GAZ (Rouleau)  
 Henco Mehrschichtverbundrohr GAS (Rohr)

Article number	Coil / Pallet	Type	Pallet dimension (mm)
50-260320-GAS*	50 m / 800 m	26x3	800x800
50-320326-GAS*	50 m / 650 m	32x3	900x900

*\*TILL EXHAUSTION OF STOCK*

## Type: STRAIGHT LENGTH GAS



Henco multilayer pipe GAS (Straight length)  
 Henco meerlagenbuis GAS (Stang)  
 Henco tube multicouche GAZ (Rouleau)  
 Henco Mehrschichtverbundrohr GAS (Stange)

Article number	Cylinder / Pallet	Type	Floor space (mm)
05-160212-GAS	125 m / 6000 m	16x2	5100x705
05-200216-GAS	90 m / 4320 m	20x2	5100x705
05-260320-GAS	50 m / 2400 m	26x3	5100x705
05-320326-GAS	35 m / 1680 m	32x3	5100x705
05-403533-GAS	45 m / 1080 m	40x3,5	5100x705

## Type: GAS PIPE IN PIPE



Henco multilayer piper with colour coded conduit GAS (Coil)  
 Henco meerlagenbuis met mantel GAS (Rol)  
 Henco tube multicouche avec gaine GAZ (Rouleau)  
 Henco Mehrschichtverbundrohr mit Mantel GAS (Ring)

Article number	Coil / Pallet	Type	Pallet dimension (mm)
25-016GASMG	25 m / 500 m	16x2	1200x800
50-016GASMG	50 m / 800 m	16x2	1200x800
25-020GASMG	25 m / 500 m	20x2	1200x800
50-020GASMG	50 m / 800 m	20x2	1200x800
50-026GASMG	50 m / 500 m	26x3	1200x800
25-032GASMG	25 m / 300 m	32x3	1200x800
25-026GASMG	25 m / 500 m	26x3	1200x800

*Gastec: Standard pipe gas in combination with Henco press fittings synthetic for gas, see page 46*

*DVGW and Kiwa Uni: Standard pipe gas in combination with Henco brass press fittings for gas, see page 86*



- 1
- 2
- 3
- 4
- 5
- 6
- 7
- 8
- 9
- 10
- 11
- 12



# Henco Pipes

SPRINKLER STANDARD (PE-Xc/AL/PE-Xc)

- 1
- 2
- 3
- 4
- 5
- 6
- 7
- 8
- 9
- 10
- 11
- 12

*Sprinkler: only allowed in countries where a HENCO Sprinkler certificate is available! (see [www.henco.be](http://www.henco.be))*  
*Sprinkler: enkel toegelaten in landen waar een HENCO Sprinkler certificaat voorhanden is! (zie [www.henco.be](http://www.henco.be))*  
*Sprinkler: seulement permis dans des pays où le HENCO Sprinkler certificat est disponible! (consultez [www.henco.be](http://www.henco.be))*  
*Sprinkler: nur zugelassen in Länder wo HENCO Sprinkler Zertifikat vorhanden ist! (siehe [www.henco.be](http://www.henco.be))*

## Type: COIL SPR



**Henco multilayer pipe SPRINKLER (Coil)**  
**Henco meerlagenbuis SPRINKLER (rol)**  
**Henco tube multicouche SPRINKLER (Rouleau)**  
**Henco Mehrschichtverbundrohr SPRINKLER (Rohr)**

Article number	Coil / Pallet	Type	Pallet dimension (mm)
50-320326-SPR	50 m / 650 m	32x3	900x900

## Type: STRAIGHT LENGTH SPR



**Henco multilayer pipe SPRINKLER (Straight length)**  
**Henco meerlagenbuis SPRINKLER (Stang)**  
**Henco tube multicouche SPRINKLER (Barre)**  
**Henco Mehrschichtverbundrohr SPRINKLER (Stange)**

Article number	Cylinder / Pallet	Type	Floor space (mm)
05-320326-SPR	35 m / 1680 m	32x3	5100x705
05-403533-SPR	45 m / 1080 m	40x3,5	5100x705
05-504042-SPR	35 m / 840 m	50x4	5100x705
05-634554-SPR	20 m / 480 m	63x4,5	5100x705

Standard pipe Sprinkler in combination with Henco press fittings synthetic for Sprinkler, see page 163  
 Sprinkler Cup: see chapter 12 on Sprinkler systems







	<i>Page</i>
<i><b>Henco Press - PK</b></i>	<i><b>26</b></i>
<i><b>Henco Press WHITE - PKW</b></i>	<i><b>38</b></i>
<i><b>Henco Press GAS - PKG</b></i>	<i><b>46</b></i>
<i><b>Henco Press SUPER SIZES</b></i>	<i><b>51</b></i>
<i><b>Henco Ecoline</b></i>	<i><b>62</b></i>



## Henco PVDF Press

Henco Press BLACK - PK

### Type: 1PK



Elbow 90°  
Knie 90°  
Coude 90°  
Winkel 90°

Article number	Bag / Box	Type
1PK-1414	10 pc. / 150 pc.	14x14
1PK-1616	10 pc. / 120 pc.	16x16
1PK-1818	10 pc. / 100 pc.	18x18
1PK-2020	10 pc. / 80 pc.	20x20
1PK-2626	5 pc. / 50 pc.	26x26
1PK-3232	5 pc. / 30 pc.	32x32
1PK-4040	5 pc. / 20 pc.	40x40
1PK-5050	1 pc. / 8 pc.	50x50
1PK-6363	1 pc. / 6 pc.	63x63

### Type: 1PK-JG



Elbow 90° 16x10JG (ceiling cooling)  
Knie 90° 16x10JG (koelplafond)  
Coude 90° 16x10JG (plafond climatisé)  
Winkel 90° 16x10JG (Klimadecke)

Article number	Bag / Box	Type
1PK-16JG10*	10 pc. / 120 pc.	16x10JG
1PK-20JG10	10 pc. / 100 pc.	20x10JG

*\*TILL EXHAUSTION OF STOCK*

### Type: 2PK (CW617)



Backplate elbow female  
Sanitair muurplaat binnendraad  
Culasse pour sanitaire  
Sanitär Wandscheibe IG

Article number	Bag / Box	Type
2PK-1404BP	10 pc. / 50 pc.	14x1/2"
2PK-1603	10 pc. / 50 pc.	16x3/8"
2PK-1604BP	10 pc. / 50 pc.	16x1/2"
2PK-1804BP	10 pc. / 50 pc.	18x1/2"
2PK-2004BP	10 pc. / 50 pc.	20x1/2"
2PK-2005	5 pc. / 30 pc.	20x3/4"
2PK-2605	5 pc. / 30 pc.	26x3/4"

### Type: 2PK-X (INOX 316 L)



Backplate elbow female Inox  
Sanitair muurplaat binnendraad Inox  
Culasse pour sanitaire Inox  
Sanitär Wandscheibe IG Inox

Article number	Bag / Box	Type
2PK-1404-X	10 pc. / 50 pc.	14x1/2"
2PK-1604-X	10 pc. / 50 pc.	16x1/2"
2PK-1804-X	10 pc. / 50 pc.	18x1/2"
2PK-2004-X	10 pc. / 50 pc.	20x1/2"
2PK-2005-X	5 pc. / 30 pc.	20x3/4"
2PK-2605-X	5 pc. / 30 pc.	26x3/4"



1

2

3

4

5

6

7

8

9

10

11

12



**Did you know** you could use our galvanised bracket plates for the 2PK, 2PK-X and 2PK-K fittings?

> Find more information on **p. 159**

## Type: 2PK-K (CW617)



**Backplate elbow female, short model**  
**Sanitair muurplaat binnendraad, laag**  
**Culasse double pour sanitaire, modèle court**  
**Sanitär Wandscheibe IG, kurzes Modell**

Article number	Bag / Box	Type
2PK-1604KBP	10 pc. / 50 pc.	16x1/2"

## Type: 3PK (CW617)



**Double backplate elbow female, short model**  
**Sanitair muurplaat binnendraad dubbel, laag**  
**Culasse double pour sanitaire, modèle court**  
**Sanitär Wandscheibe doppelt IG, kurzes Modell**

Article number	Bag / Box	Type
3PK-160416BP	10 pc. / 30 pc.	16x1/2"x16
3PK-200420BP	10 pc. / 30 pc.	20x1/2"x20

## Type: 3PK-X (INOX 316 L)



**Double backplate elbow female, short model INOX**  
**Sanitair muurplaat binnendraad dubbel INOX**  
**Culasse double pour sanitaire, modèle court INOX**  
**Sanitär Wandscheibe doppelt IG, kurzes Modell INOX**

Article number	Bag / Box	Type
3PK-160416-X	10 pc. / 30 pc.	16x1/2"x16 (40 mm)
3PK-200420-X	10 pc. / 30 pc.	20x1/2"x20 (40 mm)

## Type: BP04



**Black plug for 1/2" backplate**  
**Zwarte stop voor 1/2" muurplaat**  
**Bouchon noir pour 1/2" culasse**  
**Schwarzen Stopf für 1/2" Wandscheibe**

Article number	Bag / Box	Type
BP04	50 pc. / 500 pc.	1/2"

Not suited for testing



## Henco PVDF Press

Henco Press BLACK - PK

1

2

3

4

5

6

7

8

9

10

11

12



**Did you know** you could use the PK-tool wrench for PK and SK fittings to realise an even quicker installation of threaded Henco fittings.

> Find more information on **p. 154**

Type: 5PK (CW617) 



Elbow 90° male adapter

Knie 90° buitendraad

Coude 90° mâle

Winkel 90° AG

Article number	Bag / Box	Type
5PK-1404	10 pc. / 60 pc.	14x1/2"
5PK-1604	10 pc. / 60 pc.	16x1/2"
5PK-1804	10 pc. / 60 pc.	18x1/2"
5PK-2004	10 pc. / 60 pc.	20x1/2"
5PK-2005	10 pc. / 50 pc.	20x3/4"
5PK-2605	10 pc. / 40 pc.	26x3/4"
5PK-3206	5 pc. / 20 pc.	32x1"
5PK-4007	3 pc. / 15 pc.	40x5/4"
5PK-5007	1 pc. / 10 pc.	50x5/4"
5PK-5008	1 pc. / 8 pc.	50x6/4"
5PK-6310	1 pc. / 4 pc.	63x2"

Type: 5PK-N (CW602) 



Elbow 90° male adapter CW602

Knie 90° buitendraad CW602

Coude 90° mâle CW602

Winkel 90° AG CW602

Article number	Bag / Box	Type
5PK-4007-N	3 pc. / 15 pc.	40x5/4"
5PK-5007-N	1 pc. / 10 pc.	50x5/4"
5PK-5008-N	1 pc. / 8 pc.	50x6/4"
5PK-6310-N	1 pc. / 4 pc.	63x2"

Type: 6PK (CW617) 



Elbow 90° female adapter

Knie 90° binnendraad

Coude 90° femelle

Winkel 90° IG

Article number	Bag / Box	Type
6PK-1404BP	10 pc. / 60 pc.	14x1/2"
6PK-1603	10 pc. / 60 pc.	16x3/8"
6PK-1604BP	10 pc. / 60 pc.	16x1/2"
6PK-1804BP	10 pc. / 60 pc.	18x1/2"
6PK-2004BP	10 pc. / 60 pc.	20x1/2"
6PK-2005	10 pc. / 50 pc.	20x3/4"
6PK-2605	10 pc. / 50 pc.	26x3/4"
6PK-3206	5 pc. / 20 pc.	32x1"
6PK-4007	5 pc. / 15 pc.	40x5/4"
6PK-5007	1 pc. / 8 pc.	50x5/4"
6PK-5008	1 pc. / 8 pc.	50x6/4"
6PK-6310	1 pc. / 4 pc.	63x2"



Diameter 75mm / 90mm **SUPERSIZES p. 51**

**Type: 6PK-X (INOX 316 L)** 



**Elbow 90° female adapter INOX**  
**Knie 90° binnendraad INOX**  
**Coude 90° femelle INOX**  
**Winkel 90° IG INOX**

Article number	Bag / Box	Type
6PK-1404-X	10 pc. / 60 pc.	14x1/2"
6PK-1604-X	10 pc. / 60 pc.	16x1/2"
6PK-1804-X	10 pc. / 60 pc.	18x1/2"
6PK-2004-X	10 pc. / 60 pc.	20x1/2"
6PK-2005-X	10 pc. / 50 pc.	20x3/4"
6PK-2605-X	10 pc. / 50 pc.	26x3/4"
6PK-3206-X	5 pc. / 20 pc.	32x1"
6PK-4007-X	5 pc. / 15 pc.	40x1 1/4"
6PK-5007-X	1 pc. / 8 pc.	50x1 1/4"
6PK-5008-X	1 pc. / 8 pc.	50x1 1/2"
6PK-6310-X	1 pc. / 4 pc.	63x2"

**Type: 6PK-N (CW602)** 



**Elbow 90° female adapter CW602**  
**Knie 90° binnendraad CW602**  
**Coude 90° femelle CW602**  
**Winkel 90° IG CW602**

Article number	Bag / Box	Type
6PK-4007-N	5 pc. / 15 pc.	40x5/4"
6PK-5007-N	1 pc. / 8 pc.	50x5/4"
6PK-5008-N	1 pc. / 8 pc.	50x6/4"
6PK-6310-N	1 pc. / 4 pc.	63x2"

**Type: 9PK**



**T-piece**  
**T-stuk**  
**Pièce en T**  
**T-Stück**

Article number	Bag / Box	Type
9PK-141414	10 pc. / 100 pc.	14x14x14
9PK-161616	10 pc. / 60 pc.	16x16x16
9PK-181818	10 pc. / 60 pc.	18x18x18
9PK-202020	10 pc. / 50 pc.	20x20x20
9PK-262626	5 pc. / 30 pc.	26x26x26
9PK-323232	5 pc. / 15 pc.	32x32x32
9PK-404040	5 pc. / 10 pc.	40x40x40
9PK-505050	1 pc. / 6 pc.	50x50x50
9PK-636363	1 pc. / 3 pc.	63x63x63

- 1
- 2
- 3
- 4
- 5
- 6
- 7
- 8
- 9
- 10
- 11
- 12



## Henco PVDF Press

Henco Press BLACK - PK

### Type: 10PK



T-reduced centre

T-verlopend

Pièce en T réduit

T-reduziert

Article number	Bag / Box	Type
10PK-161416	10 pc. / 50 pc.	16x14x16
10PK-181418	10 pc. / 50 pc.	18x14x18
10PK-181618	10 pc. / 50 pc.	18x16x18
10PK-201420	10 pc. / 50 pc.	20x14x20
10PK-201620	10 pc. / 50 pc.	20x16x20
10PK-201820	10 pc. / 50 pc.	20x18x20
10PK-261626	5 pc. / 30 pc.	26x16x26
10PK-261826	5 pc. / 30 pc.	26x18x26
10PK-262026	5 pc. / 30 pc.	26x20x26
10PK-321632	5 pc. / 25 pc.	32x16x32
10PK-321832	5 pc. / 25 pc.	32x18x32
10PK-322032	5 pc. / 25 pc.	32x20x32
10PK-322632	5 pc. / 20 pc.	32x26x32
10PK-401640	5 pc. / 15 pc.	40x16x40
10PK-402040	5 pc. / 15 pc.	40x20x40
10PK-402640	5 pc. / 15 pc.	40x26x40
10PK-403240	5 pc. / 10 pc.	40x32x40
10PK-502050	1 pc. / 6 pc.	50x20x50
10PK-502650	1 pc. / 8 pc.	50x26x50
10PK-503250	1 pc. / 8 pc.	50x32x50
10PK-504050	1 pc. / 6 pc.	50x40x50
10PK-632663	1 pc. / 4 pc.	63x26x63
10PK-633263	1 pc. / 3 pc.	63x32x63
10PK-634063	1 pc. / 3 pc.	63x40x63
10PK-635063	1 pc. / 3 pc.	63x50x63

### Type: 10PK-JG



T-reduced centre (ceiling cooling)

T-verlopend (koelplafond)

Pièce en T-réduit (plafond climatisé)

T-reduziert (Klimadecke)

Article number	Bag / Box	Type
10PK-16JG1016*	10 pc. / 50 pc.	16x10JGx16
10PK-20JG1020	10 pc. / 50 pc.	20x10JGx20

\*TILL EXHAUSTION OF STOCK



## Type: 11PK



**T-branch and line reduced**

**T-2x verlopend**

**Pièce en T 2x réduit**

**T-2x reduziert**

Article number	Bag / Box	Type
11PK-161414	10 pc. / 50 pc.	16x14x14
11PK-181616	10 pc. / 50 pc.	18x16x16
11PK-201616	10 pc. / 50 pc.	20x16x16
11PK-201818	10 pc. / 50 pc.	20x18x18
11PK-202016	10 pc. / 50 pc.	20x20x16
11PK-261616	10 pc. / 50 pc.	26x16x16
11PK-261620	5 pc. / 30 pc.	26x16x20
11PK-262016	5 pc. / 30 pc.	26x20x16
11PK-262020	5 pc. / 30 pc.	26x20x20
11PK-262616	5 pc. / 30 pc.	26x26x16
11PK-262620	5 pc. / 30 pc.	26x26x20
11PK-322026	5 pc. / 20 pc.	32x20x26
11PK-322626	5 pc. / 20 pc.	32x26x26
11PK-402032	5 pc. / 15 pc.	40x20x32
11PK-402632	5 pc. / 15 pc.	40x26x32
11PK-403232	5 pc. / 10 pc.	40x32x32
11PK-404026	5 pc. / 10 pc.	40x40x26
11PK-404032	5 pc. / 10 pc.	40x40x32
11PK-502040	1 pc. / 10 pc.	50x20x40
11PK-502640	1 pc. / 10 pc.	50x26x40
11PK-503240	1 pc. / 10 pc.	50x32x40
11PK-504040	1 pc. / 8 pc.	50x40x40

## Type: 12PK



**T-enlarged branch**

**T-vergroot**

**Pièce en T agrandi**

**T-erweitert**

Article number	Bag / Box	Type
12PK-161816	10 pc. / 50 pc.	16x18x16
12PK-162016	10 pc. / 50 pc.	16x20x16
12PK-202620	5 pc. / 30 pc.	20x26x20
12PK-263226	5 pc. / 20 pc.	26x32x26
12PK-324032	5 pc. / 15 pc.	32x40x32
12PK-405040	1 pc. / 8 pc.	40x50x40

1

2

3

4

5

6

7

8

9

10

11

12



## Henco PVDF Press

Henco Press BLACK - PK

### Type: 13PK

1

2

3

4

5

6

7

8

9

10

11

12



T-female centre

T-binnendraad

Pièce en T femelle

T-IG

Article number	Bag / Box	Type
13PK-160416BP	10 pc. / 50 pc.	16x1/2"x16
13PK-180418BP	10 pc. / 50 pc.	18x1/2"x18
13PK-200420BP	10 pc. / 50 pc.	20x1/2"x20
13PK-200520	10 pc. / 30 pc.	20x3/4"x20
13PK-260420BP	5 pc. / 30 pc.	26x1/2"x20
13PK-260426BP	5 pc. / 30 pc.	26x1/2"x26
13PK-260526	5 pc. / 30 pc.	26x3/4"x26
13PK-320532	5 pc. / 15 pc.	32x3/4"x32
13PK-320632	5 pc. / 10 pc.	32x1"x32
13PK-320732	5 pc. / 10 pc.	32x5/4"x32
13PK-400540	5 pc. / 10 pc.	40x3/4"x40
13PK-400640	5 pc. / 10 pc.	40x1"x40
13PK-400740	5 pc. / 10 pc.	40x5/4"x40
13PK-500550	1 pc. / 6 pc.	50x3/4"x50
13PK-500850	1 pc. / 4 pc.	50x6/4"x50
13PK-631063	1 pc. / 2 pc.	63x2"x63

### Type: 13PK-X (INOX 316 L)



T-female centre INOX

T-binnendraad INOX

Pièce en T femelle INOX

T-IG INOX

Article number	Bag / Box	Type
13PK-160416-X	10 pc. / 50 pc.	16x1/2"x16
13PK-180418-X	10 pc. / 50 pc.	18x1/2"x18
13PK-200420-X	10 pc. / 50 pc.	20x1/2"x20
13PK-200520-X	10 pc. / 30 pc.	20x3/4"x20
13PK-260420-X	5 pc. / 30 pc.	26x1/2"x20
13PK-260426-X	5 pc. / 30 pc.	26x1/2"x26
13PK-260526-X	5 pc. / 30 pc.	26x3/4"x26
13PK-320532-X	5 pc. / 15 pc.	32x3/4"x32
13PK-320632-X	5 pc. / 10 pc.	32x1"x32
13PK-320732-X	5 pc. / 10 pc.	32x5/4"x32
13PK-400540-X	5 pc. / 10 pc.	40x3/4"x40
13PK-400640-X	5 pc. / 10 pc.	40x1"x40
13PK-400740-X	5 pc. / 10 pc.	40x5/4"x40
13PK-500550-X	1 pc. / 6 pc.	50x3/4"x50
13PK-500850-X	1 pc. / 4 pc.	50x6/4"x50
13PK-631063-X	1 pc. / 2 pc.	63x2"x63

### Type: 13PK-N (CW602)



T-female centre CW602

T-binnendraad CW602

Pièce en T femelle CW602

T-IG CW602

Article number	Bag / Box	Type
13PK-400540-N	5 pc. / 10 pc.	40x3/4"x40
13PK-400640-N	5 pc. / 10 pc.	40x1"x40
13PK-400740-N	5 pc. / 10 pc.	40x5/4"x40
13PK-500550-N	1 pc. / 6 pc.	50x3/4"x50
13PK-500850-N	1 pc. / 4 pc.	50x6/4"x50
13PK-631063-N	1 pc. / 2 pc.	63x2"x63





Diameter 75mm / 90mm **SUPERSIZES p. 51**



**Did you know** you could use the PK-tool wrench for PK and SK fittings to realise an even quicker installation of threaded Henco fittings.

> Find more information on **p. 154**

**Type: 14PK (CW617)** 



T-male centre  
T-buitendraad  
Pièce en T mâle  
T-AG

Article number	Bag / Box	Type
14PK-160416	10 pc. / 50 pc.	16x1/2"x16
14PK-180418	10 pc. / 50 pc.	18x1/2"x18
14PK-200420	10 pc. / 40 pc.	20x1/2"x20
14PK-200520	10 pc. / 30 pc.	20x3/4"x20
14PK-260426	5 pc. / 30 pc.	26x1/2"x26
14PK-260526	5 pc. / 25 pc.	26x3/4"x26
14PK-260626	5 pc. / 20 pc.	26x1"x26
14PK-320532	5 pc. / 15 pc.	32x3/4"x32
14PK-400640	5 pc. / 10 pc.	40x1"x40
14PK-400740	5 pc. / 10 pc.	40x5/4"x40
14PK-500850	1 pc. / 5 pc.	50x6/4"x50
14PK-631063	1 pc. / 2 pc.	63x2"x63

**Type: 14PK-N (CW602)** 



T-male centre CW602  
T-buitendraad CW602  
Pièce en T mâle CW602  
T-AG CW602

Article number	Bag / Box	Type
14PK-400640-N	5 pc. / 10 pc.	40x1"x40
14PK-400740-N	5 pc. / 10 pc.	40x5/4"x40
14PK-500850-N	1 pc. / 5 pc.	50x6/4"x50
14PK-631063-N	1 pc. / 2 pc.	63x2"x63

**Type: 15PK**



Straight coupling  
Perssok  
Manchon  
Kupplung

Article number	Bag / Box	Type
15PK-1414	10 pc. / 150 pc.	14x14
15PK-1616	10 pc. / 150 pc.	16x16
15PK-1818	10 pc. / 100 pc.	18x18
15PK-2020	10 pc. / 80 pc.	20x20
15PK-2626	5 pc. / 50 pc.	26x26
15PK-3232	5 pc. / 30 pc.	32x32
15PK-4040	5 pc. / 25 pc.	40x40
15PK-5050	1 pc. / 12 pc.	50x50
15PK-6363	1 pc. / 9 pc.	63x63



## Henco PVDF Press

Henco Press BLACK - PK

### Type: 16PK



Reducing coupling  
Verloopstuk  
Réduction  
Kupplung-reduziert

Article number	Bag / Box	Type
16PK-1614	10 pc. / 100 pc.	16x14
16PK-1814	10 pc. / 100 pc.	18x14
16PK-1816	10 pc. / 100 pc.	18x16
16PK-2014	10 pc. / 100 pc.	20x14
16PK-2016	10 pc. / 100 pc.	20x16
16PK-2018	10 pc. / 100 pc.	20x18
16PK-2616	5 pc. / 60 pc.	26x16
16PK-2618	5 pc. / 50 pc.	26x18
16PK-2620	5 pc. / 50 pc.	26x20
16PK-3216	5 pc. / 50 pc.	32x16
16PK-3220	5 pc. / 40 pc.	32x20
16PK-3226	5 pc. / 40 pc.	32x26
16PK-4026	5 pc. / 30 pc.	40x26
16PK-4032	5 pc. / 25 pc.	40x32
16PK-5032	1 pc. / 15 pc.	50x32
16PK-5040	1 pc. / 15 pc.	50x40
16PK-6340	1 pc. / 8 pc.	63x40
16PK-6350	1 pc. / 8 pc.	63x50

### Type: 17PK (CW617)



Straight male adapter  
Puntstuk  
Raccord droit mâle  
Übergangsfitting AG

Article number	Bag / Box	Type
17PK-1404	10 pc. / 80 pc.	14x1/2"
17PK-1604	10 pc. / 80 pc.	16x1/2"
17PK-1804	10 pc. / 80 pc.	18x1/2"
17PK-1805	10 pc. / 50 pc.	18x3/4"
17PK-2004	10 pc. / 80 pc.	20x1/2"
17PK-2005	10 pc. / 50 pc.	20x3/4"
17PK-2605	10 pc. / 50 pc.	26x3/4"
17PK-2606	10 pc. / 40 pc.	26x1"
17PK-3206	10 pc. / 40 pc.	32x1"
17PK-3207	5 pc. / 25 pc.	32x5/4"
17PK-4006	5 pc. / 25 pc.	40x1"
17PK-4007	5 pc. / 25 pc.	40x5/4"
17PK-5008	1 pc. / 10 pc.	50x6/4"
17PK-6310	1 pc. / 6 pc.	63x2"

### Type: 17PK-N (CW602)



Straight male adapter CW602  
Puntstuk CW602  
Raccord droit mâle CW602  
Übergangsfitting AG CW602

Article number	Bag / Box	Type
17PK-4006-N	5 pc. / 25 pc.	40x1"
17PK-4007-N	5 pc. / 25 pc.	40x5/4"
17PK-5008-N	1 pc. / 10 pc.	50x6/4"
17PK-6310-N	1 pc. / 6 pc.	63x2"



Diameter 75mm / 90mm **SUPERSIZES p. 51**



**Did you know** you could use the PK-tool wrench for PK and SK fittings to realise an even quicker installation of threaded Henco fittings.

> Find more information on **p. 154**

**Type: 18PK (CW617)** 



**Straight female adapter**  
**Schroefbus**  
**Raccord droit femelle**  
**Übergangsfitting IG**

Article number	Bag / Box	Type
18PK-1404	10 pc. / 80 pc.	14x1/2"
18PK-1604	10 pc. / 80 pc.	16x1/2"
18PK-1804	10 pc. / 80 pc.	18x1/2"
18PK-1805	10 pc. / 50 pc.	18x3/4"
18PK-2004	10 pc. / 80 pc.	20x1/2"
18PK-2005	10 pc. / 50 pc.	20x3/4"
18PK-2605	10 pc. / 50 pc.	26x3/4"
18PK-2606	10 pc. / 40 pc.	26x1"
18PK-3206	10 pc. / 40 pc.	32x1"
18PK-3207	5 pc. / 25 pc.	32x5/4"
18PK-4006	5 pc. / 25 pc.	40x1"
18PK-4007	5 pc. / 25 pc.	40x5/4"
18PK-5008	1 pc. / 10 pc.	50x6/4"
18PK-6310	1 pc. / 6 pc.	63x2"

**Type: 18PK-X (INOX 316 L)** 



**Straight female adapter INOX**  
**Schroefbus INOX**  
**Raccord droit femelle INOX**  
**Übergangsfitting IG INOX**

Article number	Bag / Box	Type
18PK-1604-X	10 pc. / 80 pc.	16x1/2"
18PK-1804-X	10 pc. / 80 pc.	18x1/2"
18PK-1805-X	10 pc. / 50 pc.	18x3/4"
18PK-2004-X	10 pc. / 80 pc.	20x1/2"
18PK-2005-X	10 pc. / 50 pc.	20x3/4"
18PK-2605-X	10 pc. / 50 pc.	26x3/4"
18PK-2606-X	10 pc. / 40 pc.	26x1"
18PK-3206-X	10 pc. / 40 pc.	32x1"
18PK-3207-X	5 pc. / 25 pc.	32x1 1/4"
18PK-4006-X	5 pc. / 25 pc.	40x1"
18PK-4007-X	5 pc. / 25 pc.	40x1 1/4"
18PK-5008-X	1 pc. / 10 pc.	50x1 1/2"
18PK-6310-X	1 pc. / 6 pc.	63x2"

- 1
- 2
- 3
- 4
- 5
- 6
- 7
- 8
- 9
- 10
- 11
- 12



## Henco PVDF Press

Henco Press BLACK - PK

### Type: 18PK-N (CW602)



Straight female adapter CW602  
Schroefbus CW602  
Raccord droit femelle CW602  
Übergangsfitting IG CW602

Article number	Bag / Box	Type
18PK-4006-N	5 pc. / 25 pc.	40x1"
18PK-4007-N	5 pc. / 25 pc.	40x5/4"
18PK-5008-N	1 pc. / 10 pc.	50x6/4"
18PK-6310-N	1 pc. / 6 pc.	63x2"

### Type: 19PK



Press fit with swivel to eurocone  
Perskoppeling met wartel en euroconus aansluiting  
Raccord à sertir avec ecrou à visser eurocone  
Pressfitting mit Drehbar und Eurokonus

Article number	Bag / Box	Type
19PK-1605	10 pc. / 80 pc.	16x3/4" EK
19PK-2005	10 pc. / 80 pc.	20x3/4" EK

### Type: 26PK



Press fitting with swivel and flat sealing  
Perskoppeling met wartel en vlakke dichting  
Raccord avec ecrou et joint plat  
Pressfitting mit Drehbar und flach Versiegelung

Article number	Bag / Box	Type
26PK-1605	10 pc. / 80 pc.	16x3/4
26PK-2005	10 pc. / 80 pc.	20x3/4

### Type: 26PK (CW617)



Press fitting with swivel and flat sealing  
Perskoppeling met wartel en vlakke dichting  
Raccord avec ecrou et joint plat  
Pressfitting mit Drehbar und flach Versiegelung

Article number	Bag / Box	Type
26PK-4007	5 pc. / 15 pc.	40x5/4"
26PK-4008	5 pc. / 15 pc.	40x1 1/2"
26PK-5008	1 pc. / 10 pc.	50x6/4"
26PK-5010	1 pc. / 10 pc.	50x2"
26PK-6310	1 pc. / 6 pc.	63x2"
26PK-6312	1 pc. / 6 pc.	63x2 1/2"



Diameter 75mm / 90mm **SUPERSIZES p. 51**

## Type: 27PK



Elbow 45°  
Knie 45°  
Coude 45°  
Winkel 45°

Article number	Bag / Box	Type
27PK-2626	5 pc. / 50 pc.	26x26
27PK-3232	5 pc. / 30 pc.	32x32
27PK-4040	5 pc. / 25 pc.	40x40
27PK-5050	1 pc. / 10 pc.	50x50
27PK-6363	1 pc. / 5 pc.	63x63

## Type: 28PK-04



Bracket wallplate for 2PK, 6PK and 13PK, interaxis 153 mm  
Muurplaatbeugel voor 2PK, 6PK en 13PK, interaxis 153 mm  
Attache culasse pour 2PK, 6PK et 13PK, entraxe 153 mm  
Bügel Wandscheibe für 2PK, 6PK und 13PK, Mitte-zu-Mitte-Abstand 153 mm

Article number	Bag / Box	Type
28PK-04	1 pc. / 50 pc.	1/2" PK Backplate

## Type: 53PK



Easy mounting fitting  
Eenvoudige montage fitting  
Raccord montage facile  
Einfache Montage Fitting

Article number	Bag / Box	Type
53PK40	1 pc. / 20 pc.	40x40
53PK50	1 pc. / 9 pc.	50x50
53PK63	1 pc. / 6 pc.	63x63

for Ø16, 20, 26 and 32, see chapter 4 article 52P

1

2

3

4

5

6

7

8

9

10

11

12



# Henco PVDF Press

Henco Press WHITE - PKW

## Type: 1PKW



Elbow 90°  
Knie 90°  
Coude 90°  
Winkel 90°

Article number	Bag / Box	Type
1PKW-1616	10 pc. / 120 pc.	16x16
1PKW-2020	10 pc. / 80 pc.	20x20
1PKW-2626	5 pc. / 50 pc.	26x26
1PKW-3232	5 pc. / 30 pc.	32x32

## Type: 2PKW (CW617)



Backplate elbow female  
Sanitair muurplaat binnendraad  
Culasse pour sanitaire  
Sanitär Wandscheibe IG

Article number	Bag / Box	Type
2PKW-1604	10 pc. / 50 pc.	16x1/2" (56 mm)
2PKW-2004	10 pc. / 50 pc.	20x1/2" (56 mm)
2PKW-2005	5 pc. / 30 pc.	20x3/4" (56 mm)
2PKW-2605	5 pc. / 30 pc.	26x3/4" (56 mm)

## Type: 2PKW-X (INOX 316 L)



Backplate elbow female INOX  
Sanitair muurplaat binnendraad INOX  
Culasse pour sanitaire INOX  
Backplate elbow female INOX

Article number	Bag / Box	Type
2PKW-1604-X	10 pc. / 50 pc.	16x1/2" (56 mm)
2PKW-2004-X	10 pc. / 50 pc.	20x1/2" (56 mm)
2PKW-2005-X	5 pc. / 30 pc.	20x3/4" (56 mm)
2PKW-2605-X	5 pc. / 30 pc.	26x3/4" (56 mm)

## Type: 2PKW-N (CW602)



Backplate elbow female CW602  
Sanitair muurplaat binnendraad CW602  
Culasse pour sanitaire CW602  
Sanitär Wandscheibe IG CW602

Article number	Bag / Box	Type
2PKW-1604-N	10 pc. / 50 pc.	16x1/2" (56 mm)
2PKW-2004-N	10 pc. / 50 pc.	20x1/2" (56 mm)
2PKW-2005-N	5 pc. / 30 pc.	20x3/4" (56 mm)
2PKW-2605-N	5 pc. / 30 pc.	26x3/4" (56 mm)



1

2

3

4

5

6

7

8

9

10

11

12



**Did you know** you could use our galvanised bracket plates for the 2PKW, 2PKW-N, 2PKW-X, 2PKW-K, 2PKW-K-N and 2PKW-K-N fittings?

> Find more information on **p. 159**

## Type: 2PKW-K (CW617)



**Backplate elbow female, short model**  
**Sanitair muurplaat binnendraad, laag**  
**Culasse pour sanitaire, modèle court**  
**Sanitär Wandscheibe IG, kurzes Modell**

Article number	Bag / Box	Type
2PKW-1604K	10 pc. / 50 pc.	16x1/2" (40 mm)

## Type: 2PKW-K-X (INOX 316 L)



**Backplate elbow female, short model INOX**  
**Sanitair muurplaat binnendraad, laag INOX**  
**Culasse pour sanitaire, modèle court INOX**  
**Sanitär Wandscheibe IG, kurzes Modell INOX**

Article number	Bag / Box	Type
2PKW-1604K-X	10 pc. / 50 pc.	16x1/2" (40 mm)

## Type: 2PKW-K-N (CW602)



**Backplate elbow female, short model CW602**  
**Sanitair muurplaat binnendraad, laag, CW602**  
**Culasse pour sanitaire, modèle court CW602**  
**Sanitär Wandscheibe IG, kurzes Modell CW602**

Article number	Bag / Box	Type
2PKW-1604K-N	10 pc. / 50 pc.	16x1/2" (40 mm)

## Type: 3PKW (CW617)



**Double backplate elbow female, short model**  
**Sanitair muurplaat binnendraad dubbel, laag**  
**Coude double plaque arrière femelle, modèle court**  
**Sanitär Wandscheibe doppelt IG, kurzes Modell**

Article number	Bag / Box	Type
3PKW-160416	10 pc. / 30 pc.	16x1/2"x16 (40 mm)
3PKW-200420	10 pc. / 30 pc.	20x1/2"x20 (40 mm)



# Henco PVDF Press

Henco Press WHITE - PKW

## Type: 3PKW-X (INOX 316 L)



Double backplate elbow female, short model INOX  
 Sanitair muurplaat binnendraad dubbel, laag INOX  
 Coude double plaque arrière femelle, modèle court INOX  
 Sanitär Wandscheibe doppelt IG, kurzes Modell INOX

Article number	Bag / Box	Type
3PKW-160416-X	10 pc. / 30 pc.	16x1/2"x16 (40 mm)
3PKW-200420-X	10 pc. / 30 pc.	20x1/2"x20 (40 mm)

## Type: 3PKW-N (CW602)



Double backplate elbow female, short model CW602  
 Sanitair muurplaat binnendraad dubbel, laag CW602  
 Coude double plaque arrière femelle, modèle court CW602  
 Sanitär Wandscheibe doppelt IG, kurzes Modell CW602

Article number	Bag / Box	Type
3PKW-160416-N	10 pc. / 30 pc.	16x1/2"x16 (40 mm)
3PKW-200420-N	10 pc. / 30 pc.	20x1/2"x20 (40 mm)

## Type: 5PKW (CW617)



Elbow 90° male adapter  
 Knie 90° buitendraad  
 Coude 90° mâle  
 Winkel 90° AG

Article number	Bag / Box	Type
5PKW-1604	10 pc. / 60 pc.	16x1/2"
5PKW-2004	10 pc. / 60 pc.	20x1/2"
5PKW-2005	10 pc. / 50 pc.	20x3/4"
5PKW-2605	10 pc. / 40 pc.	26x3/4"
5PKW-3206	5 pc. / 20 pc.	32x1"

## Type: 5PKW-N (CW602)



Elbow 90° male adapter CW602  
 Knie 90° buitendraad CW602  
 Coude 90° mâle CW602  
 Winkel 90° AG CW602

Article number	Bag / Box	Type
5PKW-1604-N	10 pc. / 60 pc.	16x1/2"
5PKW-2004-N	10 pc. / 60 pc.	20x1/2"
5PKW-2005-N	10 pc. / 50 pc.	20x3/4"
5PKW-2605-N	10 pc. / 40 pc.	26x3/4"
5PKW-3206-N	5 pc. / 20 pc.	32x1"

## Type: 6PKW (CW617)



Elbow 90° female adapter  
 Knie 90° binnendraad  
 Coude 90° femelle  
 Winkel 90° IG

Article number	Bag / Box	Type
6PKW-1603	10 pc. / 60 pc.	16x3/8"
6PKW-1604	10 pc. / 60 pc.	16x1/2"
6PKW-2004	10 pc. / 60 pc.	20x1/2"
6PKW-2005	10 pc. / 50 pc.	20x3/4"
6PKW-2605	10 pc. / 50 pc.c	26x3/4"
6PKW-3206	5 pc. / 20 pc.	32x1"





**Did you know** you could use the PK-tool wrench for PK and SK fittings to realise an even quicker installation of threaded Henco fittings.

> Find more information on **p. 154**

**Type: 6PKW-X (INOX 316 L)** 



**Elbow 90° female adapter INOX**  
**Knie 90° binnendraad INOX**  
**Coude 90° femelle INOX**  
**Winkel 90° IG INOX**

Article number	Bag / Box	Type
6PKW-1604-X	10 pc. / 60 pc.	16x1/2"
6PKW-2004-X	10 pc. / 60 pc.	20x1/2"
6PKW-2005-X	10 pc. / 50 pc.	20x3/4"
6PKW-2605-X	10 pc. / 50 pc.	26x3/4"
6PKW-3206-X	5 pc. / 20 pc.	32x1"

**Type: 6PKW-N (CW602)** 



**Elbow 90° female adapter CW602**  
**Knie 90° binnendraad CW602**  
**Coude 90° femelle CW602**  
**Winkel 90° IG CW602**

Article number	Bag / Box	Type
6PKW-1603-N	10 pc. / 60 pc.	16x3/8"
6PKW-1604-N	10 pc. / 60 pc.	16x1/2"
6PKW-2004-N	10 pc. / 60 pc.	20x1/2"
6PKW-2005-N	10 pc. / 50 pc.	20x3/4"
6PKW-2605-N	10 pc. / 50 pc.	26x3/4"
6PKW-3206-N	5 pc. / 20 pc.	32x1"

**Type: 9PKW**



**T-piece**  
**T-stuk**  
**Pièce en T**  
**T-Stück**

Article number	Bag / Box	Type
9PKW-161616	10 pc. / 60 pc.	16x16x16
9PKW-202020	10 pc. / 50 pc.	20x20x20
9PKW-262626	5 pc. / 30 pc.	26x26x26
9PKW-323232	5 pc. / 15 pc.	32x32x32

**Type: 10PKW**



**T-reduced centre**  
**T-verlopend**  
**Pièce en T réduit**  
**T-reduziert**

Article number	Bag / Box	Type
10PKW-201620	10 pc. / 50 pc.	20x16x20
10PKW-261626	5 pc. / 30 pc.	26x16x26
10PKW-262026	5 pc. / 30 pc.	26x20x26
10PKW-321632	5 pc. / 25 pc.	32x16x32
10PKW-322032	5 pc. / 25 pc.	32x20x32
10PKW-322632	5 pc. / 20 pc.	32x26x32





# Henco PVDF Press

Henco Press WHITE - PKW

## Type: 11PKW



T-branch and line reduced

T-2x verlopend

T-2x réduit

T-2x reduziert

Article number	Bag / Box	Type
11PKW-201616	10 pc. / 50 pc.	20x16x16
11PKW-202016	10 pc. / 50 pc.	20x20x16
11PKW-261616	10 pc. / 50 pc.	26x16x16
11PKW-261620	5 pc. / 30 pc.	26x16x20
11PKW-262016	5 pc. / 30 pc.	26x20x16
11PKW-262020	5 pc. / 30 pc.	26x20x20
11PKW-262616	5 pc. / 30 pc.	26x26x16
11PKW-262620	5 pc. / 30 pc.	26x26x20
11PKW-322026	5 pc. / 20 pc.	32x20x26
11PKW-322626	5 pc. / 20 pc.	32x26x26

## Type: 12PKW



T-enlarged branch

T-vergroot

T-agrandi

T-erweitert

Article number	Bag / Box	Type
12PKW-162016	10 pc. / 50 pc.	16x20x16
12PKW-202620	5 pc. / 30 pc.	20x26x20
12PKW-263226	5 pc. / 20 pc.	26x32x26

## Type: 13PKW (CW617)



T-female centre

T-binnendraad

T-femelle

T-IG

Article number	Bag / Box	Type
13PKW-160416	10 pc. / 50 pc.	16x1/2"x16
13PKW-200420	10 pc. / 50 pc.	20x1/2"x20
13PKW-200520	10 pc. / 30 pc.	20x3/4"x20
13PKW-260426	5 pc. / 30 pc.	26x1/2"x26
13PKW-260526	5 pc. / 30 pc.	26x3/4"x26
13PKW-320532	5 pc. / 15 pc.	32x3/4"x32
13PKW-320632	5 pc. / 10 pc.	32x1"x32

## Type: 13PKW-X (INOX 316 L)



T-female centre INOX

T-binnendraad INOX

T-femelle INOX

T-IG INOX

Article number	Bag / Box	Type
13PKW-160416-X	10 pc. / 50 pc.	16x1/2"x16
13PKW-200420-X	10 pc. / 50 pc.	20x1/2"x20
13PKW-200520-X	10 pc. / 30 pc.	20x3/4"x20
13PKW-260426-X	5 pc. / 30 pc.	26x1/2"x26
13PKW-260526-X	5 pc. / 30 pc.	26x3/4"x26
13PKW-320532-X	5 pc. / 15 pc.	32x3/4"x32
13PKW-320632-X	5 pc. / 10 pc.	32x1"x32



**Did you know** you could use the PK-tool wrench for PK and SK fittings to realise an even quicker installation of threaded Henco fittings.



> Find more information on **p. 154**

**Type: 13PKW-N (CW602)** 



**T-female centre CW602**  
**T-binnendraad CW602**  
**T-femelle CW602**  
**T-IG CW602**

Article number	Bag / Box	Type
13PKW-160416-N	10 pc. / 50 pc.	16x1/2"x16
13PKW-200420-N	10 pc. / 50 pc.	20x1/2"x20
13PKW-200520-N	10 pc. / 30 pc.	20x3/4"x20
13PKW-260426-N	5 pc. / 30 pc.	26x1/2"x26
13PKW-260526-N	5 pc. / 30 pc.	26x3/4"x26
13PKW-320532-N	5 pc. / 15 pc.	32x3/4"x32
13PKW-320632-N	5 pc. / 10 pc.	32x1"x32

**Type: 14PKW (CW617)** 



**T-male centre CW617**  
**T-buitendraad CW617**  
**T-mâle CW617**  
**T-AG CW617**

Article number	Bag / Box	Type
14PKW-160416	10 pc. / 50 pc.	16x1/2"x16
14PKW-200420	10 pc. / 40 pc.	20x1/2"x20
14PKW-200520	10 pc. / 30 pc.	20x3/4"x20
14PKW-320532	5 pc. / 15 pc.	32x3/4"x32

**Type: 14PKW-N (CW602)** 



**T-male centre CW602**  
**T-buitendraad CW602**  
**T-mâle CW602**  
**T-AG CW602**

Article number	Bag / Box	Type
14PKW-160416-N	10 pc. / 50 pc.	16x1/2"x16
14PKW-200420-N	10 pc. / 40 pc.	20x1/2"x20
14PKW-200520-N	10 pc. / 30 pc.	20x3/4"x20

**Type: 15PKW**



**Straight coupling**  
**Doorverbinding recht**  
**Manchon**  
**Kupplung**

Article number	Bag / Box	Type
15PKW-1616	10 pc. / 150 pc.	16x16
15PKW-2020	10 pc. / 80 pc.	20x20
15PKW-2626	5 pc. / 50 pc.	26x26
15PKW-3232	5 pc. / 30 pc.	32x32



# Henco PVDF Press

Henco Press WHITE - PKW

1

2

## Type: 16PKW



Reducing coupling  
Verloopstuk  
Réduction  
Kupplung-reduziert

Article number	Bag / Box	Type
16PKW-2016	10 pc. / 100 pc.	20x16
16PKW-2616	5 pc. / 60 pc.	26x16
16PKW-2620	5 pc. / 50 pc.	26x20
16PKW-3216	5 pc. / 50 pc.	32x16
16PKW-3220	5 pc. / 40 pc.	32x20
16PKW-3226	5 pc. / 40 pc.	32x26

3

4

5

6

7

8

## Type: 17PKW (CW617)



Straight male adapter  
Puntstuk  
Raccord droit mâle  
Übergangsfitting AG

Article number	Bag / Box	Type
17PKW-1604	10 pc. / 80 pc.	16x1/2"
17PKW-2004	10 pc. / 80 pc.	20x1/2"
17PKW-2005	10 pc. / 50 pc.	20x3/4"
17PKW-2605	10 pc. / 50 pc.	26x3/4"
17PKW-2606	10 pc. / 40 pc.	26x1"
17PKW-3206	10 pc. / 40 pc.	32x1"
17PKW-3207	5 pc. / 25 pc.	32x5/4"

9

10

11

12

## Type: 17PKW-N (CW602)



Straight male adapter CW602  
Puntstuk CW602  
Raccord droit mâle CW602  
Übergangsfitting AG CW602

Article number	Bag / Box	Type
17PKW-1604-N	10 pc. / 80 pc.	16x1/2"
17PKW-2004-N	10 pc. / 80 pc.	20x1/2"
17PKW-2005-N	10 pc. / 50 pc.	20x3/4"
17PKW-2605-N	10 pc. / 50 pc.	26x3/4"
17PKW-2606-N	10 pc. / 40 pc.	26x1"
17PKW-3206-N	10 pc. / 40 pc.	32x1"
17PKW-3207-N	5 pc. / 25 pc.	32x5/4"

## Type: 18PKW (CW617)



Straight female adapter  
Schroefbus  
Raccord droit femelle  
Übergangsfitting IG

Article number	Bag / Box	Type
18PKW-1604	10 pc. / 80 pc.	16x1/2"
18PKW-2004	10 pc. / 80 pc.	20x1/2"
18PKW-2005	10 pc. / 50 pc.	20x3/4"
18PKW-2605	10 pc. / 50 pc.	26x3/4"
18PKW-2606	10 pc. / 40 pc.	26x1"
18PKW-3206	10 pc. / 40 pc.	32x1"
18PKW-3207	5 pc. / 25 pc.	32x5/4"



## Type: 18PKW-X (INOX 316 L)



Straight female adapter INOX  
Schroefbus INOX  
Raccord droit femelle INOX  
Übergangsfitting IG INOX

Article number	Bag / Box	Type
18PKW-1604-X	10 pc. / 80 pc.	16x1/2"
18PKW-2004-X	10 pc. / 80 pc.	20x1/2"
18PKW-2005-X	10 pc. / 50 pc.	20x3/4"
18PKW-2605-X	10 pc. / 50 pc.	26x3/4"
18PKW-2606-X	10 pc. / 40 pc.	26x1"
18PKW-3206-X	10 pc. / 40 pc.	32x1"
18PKW-3207-X	5 pc. / 25 pc.	32x1 1/4"

## Type: 18PKW-N (CW602)



Straight female adapter CW602  
Schroefbus CW602  
Raccord droit femelle CW602  
Übergangsfitting IG CW602

Article number	Bag / Box	Type
18PKW-1604-N	10 pc. / 80 pc.	16x1/2"
18PKW-2004-N	10 pc. / 80 pc.	20x1/2"
18PKW-2005-N	10 pc. / 50 pc.	20x3/4"
18PKW-2605-N	10 pc. / 50 pc.	26x3/4"
18PKW-2606-N	10 pc. / 40 pc.	26x1"
18PKW-3206-N	10 pc. / 40 pc.	32x1"
18PKW-3207-N	5 pc. / 25 pc.	32x5/4"

## Type: 19PKW



Press fitting to eurocone  
Perskoppeling met euroconus aansluiting  
Raccord avec raccord à visser eurocone  
Pressfitting mit Eurokonus

Article number	Bag / Box	Type
19PKW-1605	10 pc. / 80 pc.	16x3/4" EK
19PKW-2005	10 pc. / 80 pc.	20x3/4" EK

## Type: 26PKW



Press fitting with flat sealing  
Perskoppeling met vlakke dichting  
Raccord avec etachéité plate  
Pressfitting mit flach Versiegelung

Article number	Bag / Box	Type
26PKW-1605	10 pc. / 80 pc.	16x3/4"
26PKW-2005	10 pc. / 80 pc.	20x3/4"

## Type: 27PKW



Elbow 45°  
Knie 45°  
Coude 45°  
Winkel 45°

Article number	Bag / Box	Type
27PKW-2626	5 pc. / 50 pc.	32x32
27PKW-3232	5 pc. / 30 pc.	32x32



# Henco PVDF Press

Henco Press GAS - PKG

Gas: only allowed in countries where a HENCO GAS testing + certificate is available! (see [www.henco.be](http://www.henco.be))  
 Gas: enkel toegelaten in landen waar er een HENCO GAS keur is + een certificaat voorhanden is! (zie [www.henco.be](http://www.henco.be))  
 Gaz: seulement permis dans des pays où le contrôle a eu lieu + certificat est disponible! (Consultez [www.henco.be](http://www.henco.be))  
 Gas: nur zugelassen in Länder wo HENCO GAS Prüfung geschehen ist + Zertifikat vorhanden ist! (Siehe [www.henco.be](http://www.henco.be))



## Type: 1PKG



Elbow 90°  
 Knie 90°  
 Coude 90°  
 Winkel 90°

Article number	Bag / Box	Type
1PKG-1616	10 pc. / 120 pc.	16x16
1PKG-2020	10 pc. / 80 pc.	20x20
1PKG-2626	5 pc. / 50 pc.	26x26
1PKG-3232	5 pc. / 30 pc.	32x32
1PKG-4040	5 pc. / 20 pc.	40x40

## Type: 2PKG



Backplate elbow female  
 Muurplaat binnendraad  
 Culasse femelle  
 Wandscheibe IG

Article number	Bag / Box	Type
2PKG-1603	10 pc. / 50 pc.	16x3/8"
2PKG-1604BP	10 pc. / 50 pc.	16x1/2"
2PKG-2004BP	10 pc. / 50 pc.	20x1/2"
2PKG-2005	5 pc. / 30 pc.	20x3/4"
2PKG-2605	5 pc. / 30 pc.	26x3/4"

## Type: 2PKG-K



Backplate elbow female, short model  
 Muurplaat binnendraad, laag  
 Culasse femelle, modèle court  
 Wandscheibe IG, kurzes Modell

Article number	Bag / Box	Type
2PKG-1604KBP	10 pc. / 50 pc.	16x1/2"

## Type: 5PKG



Elbow 90° male adapter  
 Knie 90° buitendraad  
 Coude 90° mâle  
 Winkel 90° AG

Article number	Bag / Box	Type
5PKG-1604	10 pc. / 60 pc.	16x1/2"
5PKG-2004	10 pc. / 60 pc.	20x1/2"
5PKG-2005	10 pc. / 50 pc.	20x3/4"
5PKG-2605	10 pc. / 40 pc.	26x3/4"
5PKG-3206	5 pc. / 20 pc.	32x1"
5PKG-4007	5 pc. / 15 pc.	40x5/4"



**Did you know** you could use the PK-tool wrench for PK and SK fittings to realise an even quicker installation of threaded Henco fittings.

> Find more information on **p. 154**

## Type: 6PKG



Elbow 90° female adapter  
Knie 90° binnendraad  
Coude 90° femelle  
Winkel 90° IG

Article number	Bag / Box	Type
6PKG-1604BP	10 pc. / 60 pc.	16x1/2"
6PKG-2004BP	10 pc. / 60 pc.	20x1/2"
6PKG-2005	10 pc. / 50 pc.	20x3/4"
6PKG-2605	10 pc. / 50 pc.	26x3/4"
6PKG-3206	5 pc. / 20 pc.	32x1"
6PKG-4007	5 pc. / 15 pc.	40x5/4"

## Type: 9PKG



T-piece  
T-stuk  
Pièce en T  
T-Stück

Article number	Bag / Box	Type
9PKG-161616	10 pc. / 60 pc.	16x16x16
9PKG-202020	10 pc. / 50 pc.	20x20x20
9PKG-262626	5 pc. / 30 pc.	26x26x26
9PKG-323232	5 pc. / 15 pc.	32x32x32
9PKG-404040	5 pc. / 10 pc.	40x40x40

## Type: 10PKG



T-reduced centre  
T-verlopend  
Pièce en T réduit  
T-reduziert

Article number	Bag / Box	Type
10PKG-201620	10 pc. / 50 pc.	20x16x20
10PKG-261626	5 pc. / 30 pc.	26x16x26
10PKG-262026	5 pc. / 30 pc.	26x20x26
10PKG-321632	5 pc. / 25 pc.	32x16x32
10PKG-322032	5 pc. / 25 pc.	32x20x32
10PKG-322632	5 pc. / 20 pc.	32x26x32
10PKG-401640*	5 pc. / 15 pc.	40x16x40
10PKG-402040	5 pc. / 15 pc.	40x20x40
10PKG-402640	5 pc. / 15 pc.	40x26x40
10PKG-403240	5 pc. / 10 pc.	40x32x40

\*TILL EXHAUSTION OF STOCK



# Henco PVDF Press

Henco Press GAS - PKG

## 1 Type: 11PKG

2

3

4

5

6

7

8

9

10

11

12



**T-branch and line reduced**

**T-2x verlopend**

**Pièce en T 2x réduit**

**T-2x reduziert**

Article number	Bag / Box	Type
11PKG-201616	10 pc. / 50 pc.	20x16x16
11PKG-202016	10 pc. / 50 pc.	20x20x16
11PKG-261620	5 pc. / 30 pc.	26x16x20
11PKG-262016	5 pc. / 30 pc.	26x20x16
11PKG-262020	5 pc. / 30 pc.	26x20x20
11PKG-262616	5 pc. / 30 pc.	26x26x16
11PKG-262620	5 pc. / 30 pc.	26x26x20
11PKG-322026	5 pc. / 20 pc.	32x20x26
11PKG-322626	5 pc. / 20 pc.	32x26x26
11PKG-402032*	5 pc. / 15 pc.	40x20x32
11PKG-402632	5 pc. / 15 pc.	40x26x32
11PKG-403232	5 pc. / 10 pc.	40x32x32
11PKG-404026	5 pc. / 10 pc.	40x40x26
11PKG-404032*	5 pc. / 10 pc.	40x40x32

*\*TILL EXHAUSTION OF STOCK*

## Type: 12PKG



**T-enlarged branch**

**T-vergroot**

**Pièce en T agrandi**

**T-erweitert**

Article number	Bag / Box	Type
12PKG-162016	10 pc. / 50 pc.	16x20x16
12PKG-202620	5 pc. / 30 pc.	20x26x20
12PKG-263226	5 pc. / 20 pc.	26x32x26
12PKG-324032	5 pc. / 10 pc.	32x40x32

## Type: 13PKG



**T-female centre**

**T-binnendraad**

**Pièce en T femelle**

**T-IG**

Article number	Bag / Box	Type
13PKG-160416BP	10 pc. / 50 pc.	16x1/2"x16
13PKG-200420BP*	10 pc. / 50 pc.	20x1/2"x20
13PKG-200520	10 pc. / 30 pc.	20x3/4"x20
13PKG-260420BP*	5 pc. / 30 pc.	26x1/2"x20
13PKG-260426BP	5 pc. / 30 pc.	26x1/2"x26
13PKG-260526	5 pc. / 30 pc.	26x3/4"x26
13PKG-320532	5 pc. / 15 pc.	32x3/4"x32
13PKG-320632	5 pc. / 10 pc.	32x1"x32
13PKG-320732	5 pc. / 10 pc.	32x5/4"x32
13PKG-400640	5 pc. / 10 pc.	40x1"x40
13PKG-400740	5 pc. / 10 pc.	40x5/4"x40

*\* TILL EXHAUSTION OF STOCK*





**Did you know** you could use the PK-tool wrench for PK and SK fittings to realise an even quicker installation of threaded Henco fittings.

> Find more information on **p. 154**

## Type: 14PKG



T-male centre  
T-buitendraad  
Pièce en T mâle  
T-AG

Article number	Bag / Box	Type
14PKG-160416	10 pc. / 50 pc.	16x1/2"x16
14PKG-200420*	10 pc. / 40 pc.	20x1/2"x20
14PKG-260426	5 pc. / 20 pc.	26x1/2"x26
14PKG-260626	5 pc. / 20 pc.	26x1"x26

*\*TILL EXHAUSTION OF STOCK*

## Type: 15PKG



Straight coupling  
Perssok  
Manchon  
Kupplung

Article number	Bag / Box	Type
15PKG-1616	10 pc. / 150 pc.	16x16
15PKG-2020	10 pc. / 80 pc.	20x20
15PKG-2626	5 pc. / 50 pc.	26x26
15PKG-3232	5 pc. / 30 pc.	32x32
15PKG-4040	5 pc. / 25 pc.	40x40

## Type: 16PKG



Reducing coupling  
Verloopstuk  
Réduction  
Kupplung-reduziert

Article number	Bag / Box	Type
16PKG-2016	10 pc. / 100 pc.	20x16
16PKG-2616	5 pc. / 60 pc.	26x16
16PKG-2620	5 pc. / 50 pc.	26x20
16PKG-3216	5 pc. / 50 pc.	32x16
16PKG-3220	5 pc. / 40 pc.	32x20
16PKG-3226	5 pc. / 40 pc.	32x26
16PKG-4026	5 pc. / 30 pc.	40x26
16PKG-4032	5 pc. / 30 pc.	40x32



# Henco PVDF Press

Henco Press GAS - PKG

## 1 Type: 17PKG

2

**Straight male adapter**  
**Puntstuk**  
**Raccord droit mâle**  
**Übergangsfitting AG**



Article number	Bag / Box	Type
17PKG-1604	10 pc. / 80 pc.	16x1/2"
17PKG-2004	10 pc. / 80 pc.	20x1/2"
17PKG-2005	10 pc. / 50 pc.	20x3/4"
17PKG-2605	10 pc. / 50 pc.	26x3/4"
17PKG-2606	10 pc. / 40 pc.	26x1"
17PKG-3206	10 pc. / 40 pc.	32x1"
17PKG-3207	5 pc. / 25 pc.	32x5/4"
17PKG-4006	5 pc. / 25 pc.	40x1"
17PKG-4007	5 pc. / 25 pc.	40x5/4"

3

## 4 Type: 18PKG

5

**Straight female adapter**  
**Schroefbus**  
**Raccord droit femelle**  
**Übergangsfitting IG**



Article number	Bag / Box	Type
18PKG-1604	10 pc. / 80 pc.	16x1/2"
18PKG-2004	10 pc. / 80 pc.	20x1/2"
18PKG-2005	10 pc. / 50 pc.	20x3/4"
18PKG-2605	10 pc. / 50 pc.	26x3/4"
18PKG-2606	10 pc. / 40 pc.	26x1"
18PKG-3206	10 pc. / 40 pc.	32x1"
18PKG-3207	5 pc. / 25 pc.	32x5/4"
18PKG-4006	5 pc. / 25 pc.	40x1"
18PKG-4007	5 pc. / 25 pc.	40x5/4"

6

## 7 Type: 27PKG



**Elbow 45°**  
**Knie 45°**  
**Coude 45°**  
**Winkel 45°**

Article number	Bag / Box	Type
27PKG-4040	5 pc. / 25 pc.	40x40



A = 75mm | B = 90mm

## Detailed overview of Super Sizes possibilities

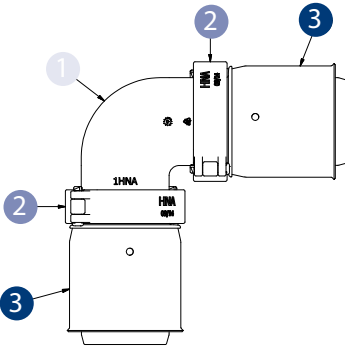

### 1PK

- 1 1HNA or 1HNB
- 2 HNA or HNB
- 3 8HNA-PK40 or 8HNA-PK50 or 8HNA-PK63 or 8HNA-PK75 or 8HNB-PK90

### Example / Voorbeeld / Exemple / Beispiel

1PK-7575 = 1x 1HNA + 2xHNA + 2x 8HNA-PK75

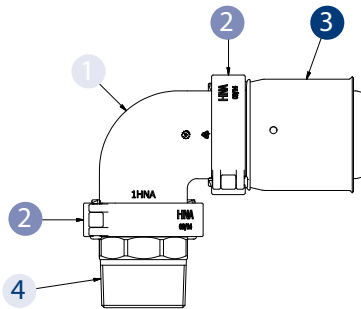

### 5PK / 6PK

- 1 1HNA or 1HNB
- 2 HNA or HNB
- 3 8HNA-PK75 or 8HNB-PK90
- 4 17HNA-10 or 17HNA-12 or 18HNA-06 or 18HNA-10 or 18HNA-12 or 18HNB-14

### Example / Voorbeeld / Exemple / Beispiel

5PK-7510 = 1x 1HNA + 2xHNA + 1x 8HNA-PK75 + 1x17HNA-10

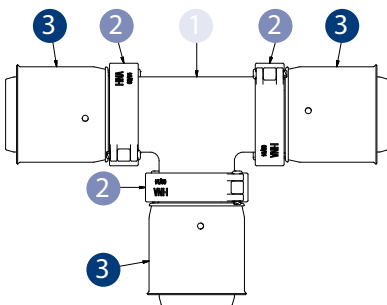

### 9PK / 10PK / 11PK / 12PK (75mm)

- 1 9HNA
- 2 HNA
- 3 8HNA-PK32 or 8HNA-PK40 or 8HNA-PK50 or 8HNA-PK63 or 8HNA-PK75

### Example / Voorbeeld / Exemple / Beispiel

9PK-757575 = 1x 9HNA + 3xHNA + 3x 8HNA-PK75

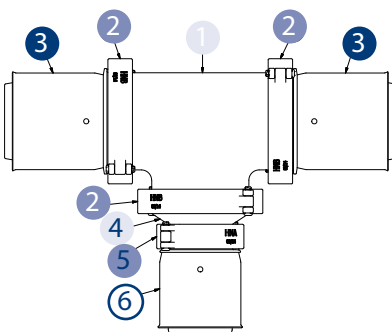

### 10PK / 11PK / 12PK (90mm)

- 1 9HNB
- 2 HNB
- 3 8HNB-PK90
- 4 16HNBA
- 5 HNA
- 6 8HNA-PK32 or 8HNA-PK40 or 8HNA-PK50 or 8HNA-PK63 or 8HNA-PK75

### Example / Voorbeeld / Exemple / Beispiel

10PK-905090 = 1x 9HNB + 3x HNB + 2x 8HNB-PK90 + 1x 16HNBA + 1xHNA + 8HNA-PK50

- 1
- 2
- 3
- 4
- 5
- 6
- 7
- 8
- 9
- 10
- 11
- 12



# Henco PVDF Press

Henco Press SUPER SIZES

A = 75mm | B = 90 mm

- 1
- 2
- 3
- 4
- 5
- 6
- 7
- 8
- 9
- 10
- 11
- 12

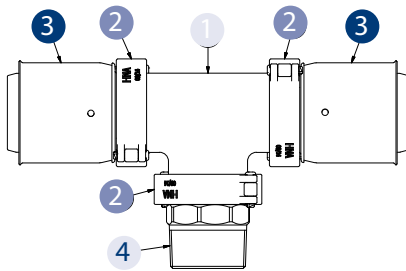

## 13PK / 14PK

- 1 9HNA or 9HNB
- 2 HNA or HNB
- 3 8HNA-PK75 or 8HNB-PK90
- 4 17HNA-10 or 17HNA-12 or 18HNA-06 or 18HNA-10 or 18HNA-12 or 18HNB-14

### Example / Voorbeeld / Exemple / Beispiel

13PK-750675 = 1x 9HNA + 3x HNA + 8HNA-PK75 + 18HNA-06

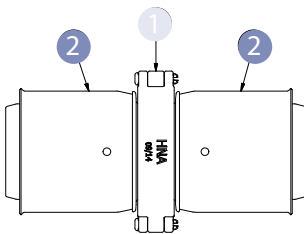

## 15PK / 16PK

- 1 HNA or HNB
- 2 8HNA-PK75 or 8HNB-PK90

### Example / Voorbeeld / Exemple / Beispiel

15PK-7575 = 1x HNA + 2x 8HNA-PK75

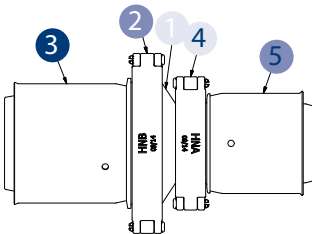

## 16PK

- 1 16HNBA
- 2 HNB
- 3 8HNB-PK90
- 4 HNA
- 5 8HNA-PK32 or 8HNA-PK40 or 8HNA-PK50 or 8HNA-PK63 or 8HNA-PK75

### Example / Voorbeeld / Exemple / Beispiel

16PK-9063 = 1x 16HNBA + 1x HNB + 1x 8HNB-PK90 + 1x HNA + 1x 8HNA-PK63

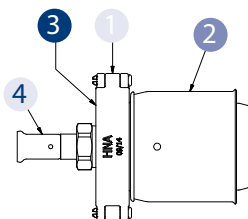

## 16PK-7516

- 1 HNA
- 2 8HNA-PK75
- 3 HNA-EK05
- 4 19P-1605 or 19P-1805 or 19P-2005 or 33P-1605 or 19SK-1605 or 19SK-2005

# Henco PVDF Press

Henco Press SUPER SIZES



A = 75mm | B = 90 mm

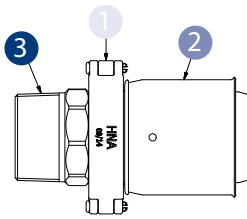

## 17PK / 18PK

- ① HNA or HNB
- ② 8HNA-PK75 or 8HNB-PK90
- ③ 17HNA or 18HNA or 18HNB

### Example / Voorbeeld / Exemple / Beispiel

18PK-7512 = 1x HNA + 1x 8HNA-PK75 + 1x 18HNA-12

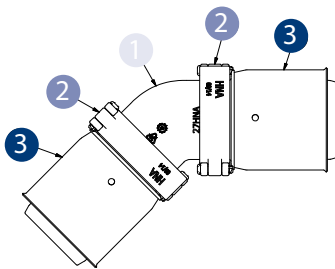

## 27PK

- ① 27HNA or 27HNB
- ② HNA or HNB
- ③ 8HNA-PK75 or 8HNB-PK90

### Example / Voorbeeld / Exemple / Beispiel

27PK-9090 = 1x 27HNB + 2xHNB + 2x 8HNB-PK90

- 1
- 2
- 3
- 4
- 5
- 6
- 7
- 8
- 9
- 10
- 11
- 12

### SUPER SIZE MONTAGE

\*HN connection = "click and lock"  
\*PK connection = press connection

### Possibilities

HNA: PK32 / PK40 / PK50 / PK63 / PK75  
HNB: PK90

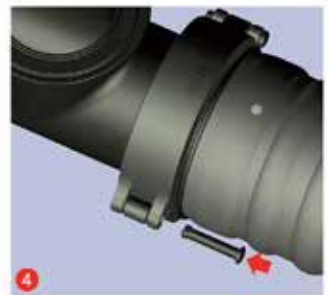
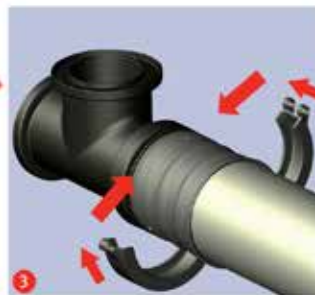
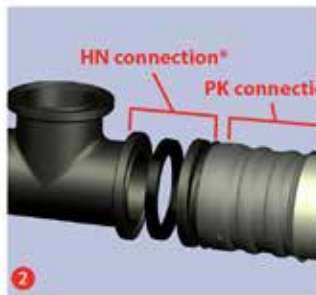



# Henco PVDF Press

Henco Press SUPER SIZES

A = 75mm | B = 90 mm

## Type: 1HN



Elbow 90°  
Knie 90°  
Coude 90°  
Winkel 90°

Article number	Bag / Box	Type
1HNA	1 pc. / 10 pc.	75x75
1HNB	1 pc.	90x90

## Type: 9HN



T-piece  
T-stuk  
Pièce en T  
T-Stück

Article number	Bag / Box	Type
9HNA	1 pc. / 7 pc.	75x75x75
9HNB	1 pc.	90x90x90

## Type: 16HN



Reducing coupling  
Verloopstuk  
Pièce en T  
Kupplung-reduziert

Article number	Bag / Box	Type
16HNBA	1 pc. / 15 pc.	90x75

## Type: 27HN



Elbow 45°  
Knie 45°  
Coude 45°  
Winkel 45°

Article number	Bag / Box	Type
27HNA	1 pc. / 15 pc.	75
27HNB	1 pc. / 4 pc.	90

## Type: 8HN



Press fitting  
Perskoppeling  
Raccord à sertir  
Pressfitting

Article number	Bag / Box	Type
8HNA-PK32	1 pc. / 20 pc.	75x32
8HNA-PK40	1 pc. / 20 pc.	75x40
8HNA-PK50	1 pc. / 12 pc.	75x50
8HNA-PK63	1 pc. / 12 pc.	75x63
8HNA-PK75	1 pc. / 12 pc.	75x75
8HNB-PK90	1 pc. / 4 pc.	90x90



A = 75mm | B = 90 mm

## Type: HN



Bracket set  
Beugelset  
Support  
Bügelset

Article number	Box	Type
HNA	1 pc.	75
HNB	1 pc.	90

## Type: HN-PEN



Locking pin  
Beugelpin  
Goupille de verrouillage  
Sicherungsstift

Article number	Bag / Box	Type
HN-PEN	50 pc. / 1000 pc.	75/90

## Type: HN-U



Sealing ring  
Dichtingsring  
Anneau d'étanchéité  
Dichtungsring

Article number	Bag	Type
HNA-U	10 pc.	75
HNB-U	10 pc.	90

## Type: 17HN (CW617)



Brass adapter male  
Messing adapter buitendraad  
Raccord en laiton mâle  
Anschluss Bügel AG

Article number	Bag / Box	Type
17HNA-10	1 pc. / 22 pc.	75x2"
17HNA-12	1 pc. / 18 pc.	75x2,5"

## Type: 17HN-N (CW602)



Brass adapter male CW602  
Messing adapter buitendraad CW602  
Raccord en laiton mâle CW602  
Anschluss Bügel AG CW602

Article number	Bag / Box	Type
17HNA-10-N	1 pc. / 22 pc.	75x2"
17HNA-12-N	1 pc. / 18 pc.	75x2,5"

## Type: 17HN-X (INOX 316 L)



Stainless steel adapter male INOX  
Inox adapter buitendraad INOX  
Raccord en acier inoxydable mâle INOX  
Anschluss Bügel aus Edelstahl (AG) INOX

Article number	Bag / Box	Type
17HNA-06-X	1 pc. / 30 pc.	75
17HNA-07-X	1 pc. / 30 pc.	75
17HNA-08-X	1 pc. / 30 pc.	75
17HNA-10-X	1 pc. / 20 pc.	75
17HNA-12-X	1 pc. / 20 pc.	75

1

2

3

4

5

6

7

8

9

10

11

12



# Henco PVDF Press

Henco Press SUPER SIZES

A = 75mm | B = 90 mm

## Type: 18HN (CW617)



Brass adapter female  
Messing adapter binnendraad  
Raccord en laiton femelle  
Anschluss Bügel IG

Article number	Bag / Box	Type
18HNA-06	1 pc. / 40 pc.	75x1"
18HNA-10	1 pc. / 27 pc.	75x2"
18HNA-12	1 pc. / 16 pc.	75x2,5"
18HNB-14	1 pc. / 12 pc.	90x3"

## Type: 18HN-N (CW602)



Brass adapter female CW602  
Messing adapter binnendraad CW602  
Raccord en laiton femelle CW602  
Anschluss Bügel IG CW602

Article number	Bag / Box	Type
18HNA-06-N	1 pc. / 40 pc.	75x1"
18HNA-10-N	1 pc. / 27 pc.	75x2"
18HNA-12-N	1 pc. / 16 pc.	75x2,5"
18HNB-14-N	1 pc. / 12 pc.	90x3"

## Type: 18HN-X (INOX 316 L)



Stainless steel adapter female  
Inox adapter binnendraad  
Raccord en acier inoxydable femelle  
Anschluss Bügel aus Edelstahl (IG)

Article number	Bag / Box	Type
18HNA-06-X	1 pc. / 30 pc.	75
18HNA-07-X	1 pc. / 30 pc.	75
18HNA-08-X	1 pc. / 30 pc.	75
18HNA-10-X	1 pc. / 20 pc.	75
18HNA-12-X	1 pc. / 20 pc.	75

## Type: HN-STOP (CW617N)



Stop end for SUPER SIZES range  
Eindstop voor SUPER SIZES gamma  
Bouchon d'arrêt SUPER SIZES  
Endkappe für das Sortiment SUPER SIZES

Article number	Bag / Box	Type
HNA-STOP*	1 pc. / 90 pc.	75
HNB-STOP	1 pc. / 40 pc.	90

\*TILL EXHAUSTION OF STOCK

## Type: HN-STOP-E (CW625N)



Stop end for SUPER SIZES range (CW625N)  
Eindstop voor SUPER SIZES gamma (CW625N)  
Bouchon d'arrêt SUPER SIZES (CW625N)  
Endkappe für das Sortiment SUPER SIZES (CW625N)

Article number	Bag / Box	Type
HNA-STOP-E	1 pc. / 50 pc.	75





A = 75mm | B = 90 mm

## Type: HNA-INLB (CW617N)



Base plate for Ecoline solution  
Basisplaat voor Ecoline oplossing  
Plaque de base pour la solution Ecoline  
Grundplatte für Ecoline-Lösung

Article number	Bag / Box	Type
HNA-INLB	1 pc. / 30 pc.	16 x 3/4"

## Type: HNA-INLB-E (CW625N)



Base plate for Ecoline solution CW625N  
Basisplaat voor Ecoline oplossing CW625N  
Plaque de base pour la solution Ecoline CW625N  
Grundplatte für Ecoline-Lösung CW625N

Article number	Bag / Box	Type
HNA-INLB-E	1 pc. / 30 pc.	16 x 3/4"

## Type: HNA-EK05 (CW617N)



Adapter HNA x EK 3/4"  
Overgang HNA x EK 3/4"  
Réduction HNA x EK 3/4"  
Übergang HNA x EK 3/4"

Article number	Bag / Box	Type
HNA-EK05*	1 pc. / 50 pc.	75 x 3/4" EK

*\*TILL EXHAUSTION OF STOCK*

## Type: HNA-EK05-E (CW625N)



Adapter HNA x EK 3/4" CW625N  
Overgang HNA x EK 3/4" CW625N  
Réduction HNA x EK 3/4" CW625N  
Übergang HNA x EK 3/4" CW625N

Article number	Bag / Box	Type
HNA-EK05-E	1 pc. / 50 pc.	75 x 3/4" EK

## Type: HN-COMP (INOX 316 L)



HN expansion bellow INOX  
HN compensator INOX  
HN compensateur INOX  
HN Kompensator INOX

Article number	Bag	Type
HNA-COMP	1 pc.	75

## Type: HN-FL (INOX 316 L)



Flange connection INOX  
Flensaansluiting INOX  
Raccordement bride INOX  
Flanschverbindung INOX

Article number	Box	Type
HNAFL-DN50	1 pc.	HNAxDN50



## Henco PVDF Press

Henco Press SUPER SIZES

1

### Type: HN-1

2



Elbow 90°

Knie 90°

Coude 90°

Winkel 90°

Article number	Box	Type
1PK-7575	1 pc.	75x75
1PK-9090	1 pc.	90x90

3

4

5

6

### Type: HN-5 (CW617N)

7



Elbow 90° male adapter

Knie 90° buitendraad

Coude 90° mâle

Winkel 90° AG

Article number	Box	Type
5PK-7510	1 pc.	75x2"
5PK-7512	1 pc.	75x2 1/2"

8

9

10

11

12

### Type: HN-6 (CW617N)



Elbow 90° female adapter

Knie 90° binnendraad

Coude 90° femelle

Winkel 90° IG

Article number	Box	Type
6PK-7506	1 pc.	75x1"
6PK-7510	1 pc.	75x2"
6PK-7512	1 pc.	75x2 1/2"
6PK-9014	1 pc.	90x3"

### Type: HN-9



T-piece

T-stuk

Pièce en T

T-Stück

Article number	Box	Type
9PK-757575	1 pc.	75x75x75
9PK-909090	1 pc.	90x90x90



## Type: HN-10



T-reduced centre  
T-verlopend  
Pièce en T réduit  
T-reduziert

Article number	Box	Type
10PK-753275	1 pc.	75x32x75
10PK-754075	1 pc.	75x40x75
10PK-755075	1 pc.	75x50x75
10PK-756375	1 pc.	75x63x75
10PK-903290	1 pc.	90x32x90
10PK-904090	1 pc.	90x40x90
10PK-905090	1 pc.	90x50x90
10PK-906390	1 pc.	90x63x90
10PK-907590	1 pc.	90x75x90

## Type: HN-11



T-branch and line reduced  
T-2x verlopend  
Pièce en T 2x réduit  
T-2x reduziert

Article number	Box	Type
11PK-753232	1 pc.	75x32x32
11PK-753240	1 pc.	75x32x40
11PK-753250	1 pc.	75x32x50
11PK-753263	1 pc.	75x32x63
11PK-754040	1 pc.	75x40x40
11PK-754050	1 pc.	75x40x50
11PK-754063	1 pc.	75x40x63
11PK-755050	1 pc.	75x50x50
11PK-755063	1 pc.	75x50x63
11PK-756363	1 pc.	75x63x63
11PK-903232	1 pc.	90x32x32
11PK-903240	1 pc.	90x32x40
11PK-903250	1 pc.	90x32x50
11PK-903263	1 pc.	90x32x63
11PK-903275	1 pc.	90x32x75
11PK-904040	1 pc.	90x40x40
11PK-904050	1 pc.	90x40x50
11PK-904063	1 pc.	90x40x63
11PK-904075	1 pc.	90x40x75
11PK-905050	1 pc.	90x50x50
11PK-905063	1 pc.	90x50x63
11PK-905075	1 pc.	90x50x75
11PK-906363	1 pc.	90x63x63
11PK-906375	1 pc.	90x63x75
11PK-907575	1 pc.	90x75x75



# Henco PVDF Press

Henco Press SUPER SIZES

## 1 Type: HN-12

2



T-enlarged branch  
T-vergroot  
Pièce en T agrandi  
T-erweitert

Article number	Box	Type
12PK-327532	1 pc.	32x75x32
12PK-329032	1 pc.	32x90x32
12PK-407540	1 pc.	40x75x40
12PK-409040	1 pc.	40x90x40
12PK-507550	1 pc.	50x75x50
12PK-509050	1 pc.	50x90x50
12PK-637563	1 pc.	63x75x63
12PK-639063	1 pc.	63x90x75
12PK-759075	1 pc.	75x90x75

3

## 9 Type: HN-13 (CW617N)

10



T-female centre  
T-binnendraad  
Pièce en T femelle  
T-IG

Article number	Box	Type
13PK-750675	1 pc.	75x1"x75
13PK-751075	1 pc.	75x2"x75
13PK-751275	1 pc.	75x2 1/2"x75
13PK-901490	1 pc.	90x3"x90

11

12

## Type: HN-14 (CW617N)



T-male centre  
T-buitendraad  
Pièce en T mâle  
T-AG

Article number	Box	Type
14PK-751075	1 pc.	75x2"x75
14PK-751275	1 pc.	75x2 1/2"x75

## Type: HN-15



Straight coupling  
Perssok  
Manchon  
Kupplung

Article number	Box	Type
15PK-7575	1 pc.	75x75
15PK-9090	1 pc.	90x90



## Type: HN-16



Reducing coupling  
Verloopstuk  
Réduction  
Kupplung-reduziert

Article number	Box	Type
16PK-7532	1 pc.	75x32
16PK-7540	1 pc.	75x40
16PK-7550	1 pc.	75x50
16PK-7563	1 pc.	75x63
16PK-9032	1 pc.	90x32
16PK-9040	1 pc.	90x40
16PK-9050	1 pc.	90x50
16PK-9063	1 pc.	90x63
16PK-9075	1 pc.	90x75

## Type: HN-17 (CW617N)



Straight male adapter  
Puntstuk  
Raccord droit mâle  
Übergangsfitting AG

Article number	Box	Type
17PK-7510	1 pc.	75x2"
17PK-7512	1 pc.	75x2 1/2"

## Type: HN-18 (CW617N)



Straight female adapter  
Schroefbus  
Raccord droit femelle  
Übergangsfitting IG

Article number	Box	Type
18PK-7506	1 pc.	75x1"
18PK-7510	1 pc.	75x2"
18PK-7512	1 pc.	75x2 1/2"
18PK-9014	1 pc.	90x3"

## Type: HN-27



Elbow 45°  
Knie 45°  
Coude 45°  
Winkel 45°

Article number	Box	Type
27PK-7575	1 pc.	75x75
27PK-9090	1 pc.	90x90

1

2

3

4

5

6

7

8

9

10

11

12



# Henco PVDF Press

Henco Ecoline

## Type: HNA-ECOLINE-SET

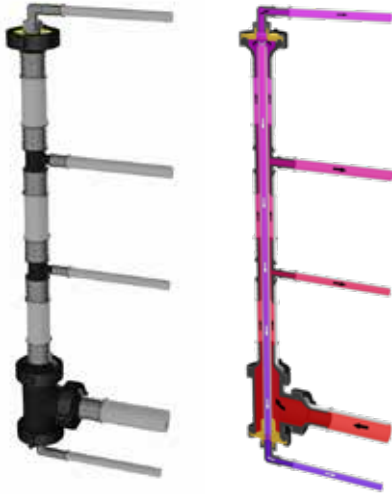

Basic set for Inliner  
 Basisset voor Inliner  
 Set de base pour Inliner  
 Grundsatz für Inliner

Article number	Bag / Box	Type
HNA-ECOLINE-SET	1 pc. / -	

Composition:  
 1x 9HNA (T-piece)  
 4x HNA (Bracket set)  
 1x HNA-EK05 (Adapter HNA-EK)  
 1x HNA-INLB (Base plate for inliner)

The Henco ECO-line is an energy saving solution for recirculation loops, which limits heat loss between supply and return pipe.

A separate pipe for the circulation water is no longer required.

Designed on the Henco Super Size concept, it also combines modularity and easy installation.

### ONE CONCEPT FOR ALL DIMENSIONS FROM 40 UP TO 75MM

- Cost effective
- Easy installation
- Less space consumption
- Anti legionellosis

### Additional items to complete the ECOLINE installation \*

Article number	Description	Page
8HNA-PK...	Press fitting 40, 50, 63 or 75	54
50-MXC1620	Henco 1L PE-Xc 16x2 - 100m	-
19P-1605	Nickel plated press-fit adapter to eurocone 16x3/4"	77
19P-2005	Nickel plated press-fit adapter to eurocone 20x3/4"	77
33P-1605	Nickel plated press-fit adapter to eurocone 90° 16x3/4"	81
19PK-1605	Press fit swivel to eurocone 16x3/4"	36
19PK-2005	Press fit swivel to eurocone 20x3/4"	36
19SK-1605	Push fitting with eurocone connection 16x3/4"	68
19SK-2005	Push fitting with eurocone connection 20x3/4"	68



\* To complete the Ecoline installation you need to have a circulator and thermostatic balancing valve (not in Henco range)



	<i>Page</i>
<i><b>Henco Vision Fittings</b></i>	<i><b>64</b></i>
<i><b>Manifolds</b></i>	<i><b>70</b></i>



## Henco Vision - Push Fit

Henco Vision Fittings

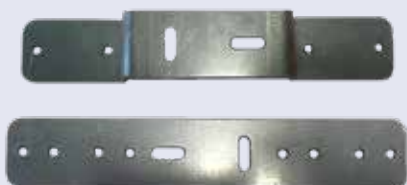

**Did you know** you could use our galvanised bracket plates for the 2SK?

> Find more information on **p. 159**

### Type: 1SK



Elbow 90°

Knie 90°

Coude 90°

Winkel 90°

Article number	Bag / Box	Type
1SK-1616	10 pc. / 70 pc.	16x16
1SK-2020	10 pc. / 50 pc.	20x20
1SK-2626	5 pc. / 40 pc.	26x26

### Type: 2SK



Backplate elbow female

Sanitair muurplaat binnendraad

Culasse pour sanitaire femelle

Sanitär Wandscheibe IG

Article number	Bag / Box	Type
2SK-1604BP	10 pc. / 40 pc.	16x1/2"
2SK-2004BP	10 pc. / 40 pc.	20x1/2"
2SK-2005	10 pc. / 30 pc.	20x3/4"
2SK-2605	5 pc. / 20 pc.	26x3/4"

### Type: 2S (CW617N)



Backplate elbow female, short model

Sanitair muurplaat binnendraad, laag

Culasse pour sanitaire femelle, modèle court

Sanitär Wandscheibe IG, kurzes Modell

Article number	Bag / Box	Type
2S-1604K	10 pc. / 50 pc.	16 x 1/2"

### Type: 3SK (CW617N)



Double backplate elbow female, short model

Dubbel sanitair muurplaat binnendraad, laag

Culasse double pour sanitaire, modèle court

Sanitär Wandscheibe doppelt IG, kurzes Modell

Article number	Bag / Box	Type
3SK-160416BP	10 pc. / 30 pc.	16x1/2"x16
3SK-200420BP	10 pc. / 30 pc.	20x1/2"x20





**Did you know** you could use the PK-tool wrench for PK and SK fittings to realise an even quicker installation of threaded Henco fittings.

> Find more information on **p. 154**

## Type: 5SK (CW617N)



Elbow 90° male adapter  
Knie 90° buitendraad  
Coude 90° mâle  
Winkel 90° AG

Article number	Bag / Box	Type
5SK-1604	10 pc. / 60 pc.	16x1/2"
5SK-2004	10 pc. / 50 pc.	20x1/2"
5SK-2005	10 pc. / 40 pc.	20x3/4"
5SK-2605	5 pc. / 30 pc.	26x3/4"

## Type: 6SK (CW617N)



Elbow 90° female adapter  
Knie 90° binnendraad  
Coude 90° femelle  
Winkel 90° IG

Article number	Bag / Box	Type
6SK-1604BP	10 pc. / 60 pc.	16x1/2"
6SK-2004BP	10 pc. / 60 pc.	20x1/2"
6SK-2005	10 pc. / 30 pc.	20x3/4"
6SK-2605	10 pc. / 30 pc.	26x3/4"

## Type: 9SK



T-piece  
T-stuk  
Pièce en T  
T-Stück

Article number	Bag / Box	Type
9SK-161616	10 pc. / 40 pc.	16x16x16
9SK-202020	10 pc. / 30 pc.	20x20x20
9SK-262626	5 pc. / 20 pc.	26x26x26

## Type: 10SK



T-reduced centre  
T-verlopend  
Pièce en T réduit  
T-reduziert

Article number	Bag / Box	Type
10SK-201620	10 pc. / 40 pc.	20x16x20
10SK-261626	5 pc. / 25 pc.	26x16x26
10SK-262026	5 pc. / 20 pc.	26x20x26

- 1
- 2
- 3
- 4
- 5
- 6
- 7
- 8
- 9
- 10
- 11
- 12



## Henco Vision - Push Fit

Henco Vision Fittings

### Type: 11SK



T-branch and line reduced

T-2x verlopend

Pièce en T 2x réduit

T-2x reduziert

Article number	Bag / Box	Type
11SK-201616	10 pc. / 40 pc.	20x16x16
11SK-202016	10 pc. / 30 pc.	20x20x16
11SK-261620	5 pc. / 25 pc.	26x16x20
11SK-262016*	5 pc. / 25 pc.	26x20x16
11SK-262020	5 pc. / 25 pc.	26x20x20
11SK-262616	5 pc. / 25 pc.	26x26x16
11SK-262620	5 pc. / 20 pc.	26x26x20

*\*TILL EXHAUSTION OF STOCK*

### Type: 12SK



T-enlarged branch

T-vergroot

Pièce en T agrandi

T-erweitert

Article number	Bag / Box	Type
12SK-162016	10 pc. / 40 pc.	16x20x16
12SK-202620	5 pc. / 30 pc.	20x26x20

### Type: 13SK (CW617N)



T-female centre

T-binnendraad

Pièce en T femelle

T-IG

Article number	Bag / Box	Type
13SK-160416BP	10 pc. / 40 pc.	16x1/2"x16
13SK-200420BP	10 pc. / 30 pc.	20x1/2"x20
13SK-200520	10 pc. / 30 pc.	20x3/4"x20
13SK-260420BP	5 pc. / 20 pc.	26x1/2"x20
13SK-260426BP	5 pc. / 20 pc.	26x1/2"x26
13SK-260526	5 pc. / 20 pc.	26x3/4"x26

### Type: 14SK (CW617N)



T-male centre

T-buitendraad

Pièce en T mâle

T-AG

Article number	Bag / Box	Type
14SK-160416	10 pc. / 40 pc.	16x1/2"x16
14SK-200420	10 pc. / 30 pc.	20x1/2"x20
14SK-260426	5 pc. / 20 pc.	26x1/2"x26



## Type: 15SK



**Straight coupling**  
**Perssok**  
**Manchon**  
**Kupplung**

Article number	Bag / Box	Type
15SK-1616	10 pc. / 70 pc.	16x16
15SK-2020	10 pc. / 60 pc.	20x20
15SK-2626	5 pc. / 30 pc.	26x26

## Type: 16SK



**Reducing coupling**  
**Verloopstuk**  
**Réduction**  
**Kupplung-reduziert**

Article number	Bag / Box	Type
16SK-2016	10 pc. / 80 pc.	20x16
16SK-2616	10 pc. / 50 pc.	26x16
16SK-2620	10 pc. / 40 pc.	26x20

## Type: 17SK (CW617N)



**Straight male adapter**  
**Puntstuk**  
**Raccord droit mâle**  
**Übergangsfitting AG**

Article number	Bag / Box	Type
17SK-1603	10 pc. / 80 pc.	16x3/8"
17SK-1604	10 pc. / 80 pc.	16x1/2"
17SK-2004	10 pc. / 60 pc.	20x1/2"
17SK-2005	10 pc. / 60 pc.	20x3/4"
17SK-2605	10 pc. / 40 pc.	26x3/4"
17SK-2606	10 pc. / 40 pc.	26x1"

## Type: 18SK (CW617N)



**Straight female adapter**  
**Schroefbus**  
**Raccord droit femelle**  
**Übergangsfitting IG**

Article number	Bag / Box	Type
18SK-1604	10 pc. / 80 pc.	16x1/2"
18SK-2004	10 pc. / 80 pc.	20x1/2"
18SK-2005	10 pc. / 60 pc.	20x3/4"
18SK-2605	10 pc. / 50 pc.	26x3/4"
18SK-2606	10 pc. / 40 pc.	26x1"



## Henco Vision - Push Fit

Henco Vision Fittings

### 1 Type: 17SKS (CW617N)

2

3



**Straight nipple male**  
**Puntstuk**  
**Raccord droit mâle**  
**Übergangsfitting AG**

Article number	Bag / Box	Type
17SKS-2004	5 pc. / 150 pc.	20x1/2"
17SKS-2005	5 pc. / 150 pc.	20x3/4"
17SKS-2604	5 pc. / 100 pc.	26x1/2"
17SKS-2605	5 pc. / 100 pc.	26x3/4"

*Applicable with HENCO Vision fittings & Full Flow Manifold*

4

5

6

7

### 8 Type: 18SKS (CW617N)

9

10



**Straight nipple female**  
**Recht aansluitstuk binnendraad**  
**Raccord droit femelle**  
**Übergangsfitting IG**

Article number	Bag / Box	Type
18SKS-2004	5 pc. / 150 pc.	20x1/2"
18SKS-2005	5 pc. / 100 pc.	20x3/4"
18SKS-2604	5 pc. / 100 pc.	26x1/2"
18SKS-2605	5 pc. / 80 pc.	26x3/4"

*Applicable with HENCO Vision fittings & Full Flow Manifold*

11

12

### Type: 19SK



**Push fitting with eurocone connection**  
**Steekkoppeling met euroconus-aansluiting**  
**Raccord push fit avec eurocone**  
**Steckkupplung mit Eurokonus**

Article number	Bag / Box	Type
19SK-1505	10 pc. / 80 pc.	15x3/4" EK
19SK-1605	10 pc. / 80 pc.	16x3/4" EK
19SK-2005	10 pc. / 80 pc.	20x3/4" EK

### Type: 26SK



**Push fitting with swivel and flat sealing**  
**Steekkoppeling met wartel en vlakke dichting**  
**Raccord push fit avec raccord ecrou étanchéité plate**  
**Steckkupplung mit Drehbar und flach Versiegelung**

Article number	Bag / Box	Type
26SK-1605	10 pc. / 80 pc.	16x3/4"
26SK-2005	10 pc. / 80 pc.	20x3/4"



## Type: SK-PIESTOP



Stop end for pipe  
Eindstop voor buis  
Bouchon pour tube  
Endkappe für Rohre

Article number	Bag / Box	Type
SK-PIESTOP16	10 pc. / 120 pc.	16
SK-PIESTOP20	10 pc. / 80 pc.	20
SK-PIESTOP26	10 pc. / 80 pc.	26

## Type: SK-STOPCLIP



Reusable stop and clip for push fit connection  
Herbruikbare stop en clip passend in een steekkoppeling  
Bouchon et clip réutilisables pour connection push fit  
Stopfen und clip für Steckanschluss, wieder verwendbar

Article number	Bag / Box	Type
SK-STOPCLIP16	10 pc. / 120 pc.	16
SK-STOPCLIP20	10 pc. / 100 pc.	20
SK-STOPCLIP26	10 pc. / 80 pc.	26

## Type: VISION SET



Vision revision set  
Vision revisie set  
Set de révision Vision  
Vision set

Article number	Bag / Box	Type
VISION SET 16	1 pc. / 100 pc.	16
VISION SET 20	1 pc. / 90 pc.	20
VISION SET 26	1 pc. / 80 pc.	26

## Type: VISION KEY



Vision disassembly key  
Vision demontage sleutel  
Clé de démontage Vision  
Vision Entriegelungsschlüssel

Article number	Bag / Box	Type
VISION-KEY16	1 pc. / 200 pc.	16
VISION-KEY20	1 pc. / 100 pc.	20
VISION-KEY26	1 pc. / 100 pc.	26



## Henco Vision - Push Fit

Manifolds

### 1 Type: VSK-1616



Extension or body for manifold, two SK connections Ø16  
Verlengstuk of basis voor verdeler, twee SK-aansluitingen Ø16  
Complément ou base collecteur, deux sorties SK Ø16  
Erweiterung oder Basiskörper für Verteiler, zwei SK-Anschlüssen Ø16

Article number	Bag / Box	Type
VSK-1616	1 pc. / 14 pc.	16-16

### 6 Type: VSK-161616



Extension or body for manifold, three SK connections Ø16  
Verlengstuk of basis voor verdeler, drie SK-aansluitingen Ø16  
Complément ou base collecteur, trois sorties SK Ø16  
Erweiterung oder Basiskörper für Verteiler, drei SK-Anschlüssen Ø16

Article number	Bag / Box	Type
VSK-161616	1 pc. / 14 pc.	16-16-16

### 11 Type: SK-B05



Bracket for manifolds  
Montagebeugel voor verdelers  
Double support pour collecteurs  
Halter für Verteiler

Article number	Bag / Box	Type
SK-B05	1 pc. / 100 pc.	B05

*See chapter 6A for more options for the Full Flow Manifold*



	<i>Page</i>
<i>Henco Brass Press Fittings</i>	<i>72</i>
<i>Henco Brass Press Fittings GAS</i>	<i>86</i>



# Henco Brass Press

Henco Brass Press Fittings

## Type: 1P



Elbow 90°  
Knie 90°  
Coude 90°  
Winkel 90°

Article number	Bag / Box	Type
1P-1616	10 pc. / 150 pc.	16x16
1P-1818*	10 pc. / 100 pc.	18x18
1P-2020	10 pc. / 80 pc.	20x20
1P-2626	5 pc. / 50 pc.	26x26
1P-3232	5 pc. / 30 pc.	32x32

*\*TILL EXHAUSTION OF STOCK*

## Type: 2P



Backplate elbow female  
Sanitair muurplaat binnendraad  
Culasse pour sanitaire femelle  
Sanitär Wandscheibe IG

Article number	Bag / Box	Type
2P-1604	10 pc. / 50 pc.	16x1/2"
2P-1804	10 pc. / 50 pc.	18x1/2"
2P-2004	10 pc. / 50 pc.	20x1/2"
2P-2005	10 pc. / 50 pc.	20x3/4"
2P-2605	5 pc. / 40 pc.	26x3/4"

## Type: 2P-K

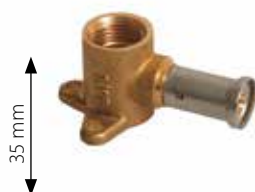

Backplate elbow female, short model  
Sanitair muurplaat binnendraad, laag  
Culasse double pour sanitaire, modèle court  
Sanitär Wandscheibe IG, kurzes Modell

Article number	Bag / Box	Type
2P-1404K	10 pc. / 50 pc.	14x1/2"
2P-1604K	10 pc. / 50 pc.	16x1/2"

## Type: 3P



Double backplate elbow female  
Sanitair muurplaat binnendraad dubbel  
Culasse double pour sanitaire  
Sanitär Wandscheibe doppelt IG

Article number	Bag / Box	Type
3P-160416	10 pc. / 40 pc.	16x1/2"x16
3P-200420	10 pc. / 40 pc.	20x1/2" x20

## Type: 3P-VK



Double backplate elbow female (flow), short model  
Doorstroom muurplaat binnendraad, laag  
Culasse double femelle (écoulement), modèle court  
Wandscheibe doppelt IG (Fluss), kurzes Modell

Article number	Bag / Box	Type
3P-160416VK	5 pc. / 20 pc.	16x1/2"x16 (40 mm)
3P-200420VK	5 pc. / 20 pc.	20x1/2"x20 (40 mm)
3P-260426VK	5 pc. / 20 pc.	26x1/2"x26 (40 mm)



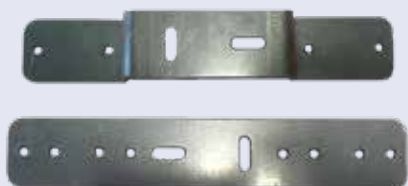

**Did you know** you could use our galvanised bracket plates for the 2P, 2P-K, 3P-VK and 4P?

> Find more information on **p. 159**

## Type: 4P



**Backplate elbow female, extended model**  
**Sanitair muurplaat binnendraad, hoog**  
**Culasse pour sanitaire femelle, modèle long**  
**Sanitär Wandscheibe IG, langes Modell**

Article number	Bag / Box	Type
4P-1604	10 pc. / 40 pc.	16x1/2"
4P-2004*	10 pc. / 40 pc.	20x1/2"

*\*TILL EXHAUSTION OF STOCK*

## Type: 5P



**Elbow 90° male adapter**  
**Knie 90° buitendraad**  
**Coude 90° mâle**  
**Winkel 90° AG**

Article number	Bag / Box	Type
5P-1603	10 pc. / 150 pc.	16x3/8"
5P-1604	10 pc. / 150 pc.	16x1/2"
5P-1804	10 pc. / 120 pc.	18x1/2"
5P-2004	10 pc. / 100 pc.	20x1/2"
5P-2005	10 pc. / 80 pc.	20x3/4"
5P-2605	10 pc. / 60 pc.	26x3/4"
5P-3206	5 pc. / 25 pc.	32x1"

## Type: 5P-DZR (CW602N)



**Elbow 90° male adapter**  
**Knie 90° buitendraad**  
**Coude 90° mâle**  
**Winkel 90° AG**

Article number	Bag / Box	Type
5P-1603DZR	10 pc. / 150 pc.	16x3/8"
5P-1604DZR	10 pc. / 150 pc.	16x1/2"

## Type: 6P



**Elbow 90° female adapter**  
**Knie 90° binnendraad**  
**Coude 90° femelle**  
**Winkel 90° IG**

Article number	Bag / Box	Type
6P-1604	10 pc. / 120 pc.	16x1/2"
6P-1804	10 pc. / 120 pc.	18x1/2"
6P-2004	10 pc. / 120 pc.	20x1/2"
6P-2005	10 pc. / 50 pc.	20x3/4"
6P-2605	5 pc. / 50 pc.	26x3/4"



# Henco Brass Press

Henco Brass Press Fittings

## Type: 7P



**Backplate elbow male**  
**Sanitair muurplaat buitendraad met binnendraad 1/2"**  
**Culasse pour sanitaire male**  
**Sanitär Wandscheibe AG**

Article number	Bag / Box	Type
7P-1605	5 pc. / 30 pc.	16x3/4" (78 mm)
7P-1605K	5 pc. / 30 pc.	16x3/4" (60 mm)
7P-1605L	5 pc. / 30 pc.	16x3/4" (70 mm)

## Type: 8P



**Sanitary adapter female**  
**Sanitair aansluitstuk met binnendraad**  
**Culasse pour sanitaire femelle**  
**UP-Spülkastenwinkel**

Article number	Bag / Box	Type
8P-1604	10 pc. / 50 pc.	16x1/2"

## Type: 9P



**T-piece**  
**T-stuk**  
**Pièce en T**  
**T-Stück**

Article number	Bag / Box	Type
9P-161616	10 pc. / 60 pc.	16x16x16
9P-181818	10 pc. / 60 pc.	18x18x18
9P-202020	10 pc. / 50 pc.	20x20x20
9P-262626	5 pc. / 30 pc.	26x26x26
9P-323232*	1 pc. / 20 pc.	32x32x32

## Type: 10P



**T-reduced centre**  
**T-verlopend**  
**Pièce en T-réduit**  
**T-reduziert**

Article number	Bag / Box	Type
10P-181618*	10 pc. / 60 pc.	18x16x18
10P-201620	10 pc. / 50 pc.	20x16x20
10P-261626	5 pc. / 30 pc.	26x16x26
10P-262026	5 pc. / 30 pc.	26x20x26
10P-321632	5 pc. / 20 pc.	32x16x32
10P-322032	5 pc. / 20 pc.	32x20x32
10P-322632*	5 pc. / 20 pc.	32x26x32

*\*TILL EXHAUSTION OF STOCK*

## Type: 11P



**T-branch and line reduced**  
**T-2x verlopend**  
**Pièce en T 2x réduit**  
**T-2x reduziert**

Article number	Bag / Box	Type
11P-201616	10 pc. / 50 pc.	20x16x16
11P-202016	10 pc. / 50 pc.	20x20x16
11P-261620	5 pc. / 30 pc.	26x16x20
11P-262020	5 pc. / 30 pc.	26x20x20
11P-262616	5 pc. / 30 pc.	26x26x16
11P-262620	5 pc. / 30 pc.	26x26x20
11P-322026*	5 pc. / 20 pc.	32x20x26
11P-322626*	5 pc. / 20 pc.	32x26x26

*\*TILL EXHAUSTION OF STOCK*



## Type: 12P



T-enlarged branch  
T-vergroot  
Pièce en T agrandi  
T-erweitert

Article number	Bag / Box	Type
12P-162016	10 pc. / 60 pc.	16x20x16
12P-202620	5 pc. / 30 pc.	20x26x20
12P-263226*	5 pc. / 20 pc.	26x32x26

\*TILL EXHAUSTION OF STOCK

## Type: 13P



T-female centre  
T-binnendraad  
Pièce en T femelle  
T-IG

Article number	Bag / Box	Type
13P-160416	10 pc. / 60 pc.	16x1/2"x16
13P-200420	10 pc. / 50 pc.	20x1/2"x20
13P-200520	10 pc. / 30 pc.	20x3/4"x20
13P-260426	5 pc. / 30 pc.	26x1/2"x26
13P-260526	5 pc. / 30 pc.	26x3/4"x26
13P-320532*	5 pc. / 20 pc.	32x3/4"x32

\*TILL EXHAUSTION OF STOCK

## Type: 14P



T-male centre  
T-buitendraad  
Pièce en T mâle  
T-AG

Article number	Bag / Box	Type
14P-160416	10 pc. / 60 pc.	16x1/2"x16
14P-200420	10 pc. / 60 pc.	20x1/2"x20
14P-200520	5 pc. / 30 pc.	20x3/4"x20
14P-260426	5 pc. / 30 pc.	26x1/2"x26

## Type: 15P



Straight coupling  
Perssok  
Manchon  
Kupplung

Article number	Bag / Box	Type
15P-1616	10 pc. / 200 pc.	16x16
15P-1818	10 pc. / 150 pc.	18x18
15P-2020	10 pc. / 140 pc.	20x20
15P-2626	5 pc. / 80 pc.	26x26
15P-3232	5 pc. / 50 pc.	32x32



# Henco Brass Press

Henco Brass Press Fittings

## Type: 16P



Reducing coupling  
Verloopstuk  
Réduction  
Kupplung-reduziert

Article number	Bag / Box	Type
16P-1816*	10 pc. / 150 pc.	18x16
16P-2016	10 pc. / 150 pc.	20x16
16P-2018*	10 pc. / 150 pc.	20x18
16P-2616	5 pc. / 100 pc.	26x16
16P-2620	5 pc. / 80 pc.	26x20
16P-3216*	5 pc. / 60 pc.	32x16
16P-3220*	5 pc. / 60 pc.	32x20
16P-3226	5 pc. / 60 pc.	32x26

*\*TILL EXHAUSTION OF STOCK*

## Type: 17P



Straight male adapter  
Puntstuk  
Raccord droit mâle  
Übergangsfitting AG

Article number	Bag / Box	Type
17P-1603	10 pc. / 150 pc.	16x3/8"
17P-1604	10 pc. / 150 pc.	16x1/2"
17P-1605	10 pc. / 150 pc.	16x3/4"
17P-1804	10 pc. / 150 pc.	18x1/2"
17P-1805	10 pc. / 150 pc.	18x3/4"
17P-2004	10 pc. / 150 pc.	20x1/2"
17P-2005	10 pc. / 150 pc.	20x3/4"
17P-2605	5 pc. / 80 pc.	26x3/4"
17P-2606	5 pc. / 80 pc.	26x1"
17P-3206	5 pc. / 50 pc.	32x1"
17P-3207	5 pc. / 40 pc.	32x5/4"

## Type: 17P-DZR (CW602N)



Straight male adapter CW602N  
Puntstuk CW602N  
Raccord droit mâle CW602N  
Übergangsfitting AG CW602N

Article number	Bag / Box	Type
17P-1603DZR	10 pc. / 150 pc.	16x3/8"
17P-1604DZR	10 pc. / 150 pc.	16x1/2"

## Type: 17P-CS (CW724N)



Straight male adapter CW724N  
Puntstuk CW724N  
Raccord droit mâle CW724N  
Übergangsfitting AG CW724N

Article number	Bag / Box	Type
17P-1604-CS	10 pc. / 170 pc.	16x1/2"
17P-2004-CS	10 pc. / 150 pc.	20x1/2"
17P-2005-CS	10 pc. / 140 pc.	20x3/4"
17P-2605-CS	10 pc. / 100 pc.	26x3/4"
17P-2606-CS	10 pc. / 80 pc.	26x1"



## Type: 18P



**Straight female adapter**  
**Schroefbus**  
**Raccord droit femelle**  
**Übergangsfitting IG**

Article number	Bag / Box	Type
18P-1604	10 pc. / 150 pc.	16x1/2"
18P-1804	10 pc. / 120 pc.	18x1/2"
18P-2004	10 pc. / 100 pc.	20x1/2"
18P-2005	10 pc. / 100 pc.	20x3/4"
18P-2605	5 pc. / 80 pc.	26x3/4"
18P-2606	5 pc. / 70 pc.	26x1"
18P-3206	5 pc. / 50 pc.	32x1"
18P-3207	5 pc. / 30 pc.	32x5/4"

## Type: 19P



**Press fit adapter to eurocone**  
**Aansluiting met wartel en euroconus koppeling**  
**Raccordement avec raccord à visser eurocone**  
**Anschlussverschraubung mit Eurokonus**

Article number	Bag / Box	Type
19P-1405	10 pc. / 150 pc.	14x3/4"
19P-1605	10 pc. / 150 pc.	16x3/4"
19P-1805	10 pc. / 150 pc.	18x3/4"
19P-2005	10 pc. / 140 pc.	20x3/4"

## Type: 24P



**Radiator connection nickel-plated 300 mm copper pipe Ø15**  
**Radiatoraansluitbocht vernikkeld met 300 mm koperbuis Ø15**  
**Alimentation radiateur nickelé 300 mm tube de cuivre Ø15**  
**Heizkörperanschluss vernickelt 300 mm Kupferrohr Ø15**

Article number	Bag / Box	Type
24P-1604	2 pc. / 50 pc.	16x15
24P-2004	2 pc. / 50 pc.	20x15

## Type: 25P



**Radiator connection nickel-plated 1100 mm copper pipe Ø15**  
**Radiatoraansluitbocht vernikkeld met 1100 mm koperbuis Ø15**  
**Alimentation radiateur nickelé 1100 mm tube de cuivre Ø15**  
**Heizkörperanschluss vernickelt 1100 mm Kupferrohr Ø15**

Article number	Bag	Type
25P-1604*	2 pc.	16x15

*\*TILL EXHAUSTION OF STOCK*



# Henco Brass Press

Henco Brass Press Fittings

## Type: 26P



**Press fitting self-filling**  
**Aansluiting met buitendraad, vlakke dichting**  
**Raccord auto-étanche**  
**Pressfitting mit AG flachdichtend**

Article number	Bag / Box	Type
26P-1604	10 pc. / 100 pc.	16x1/2"
26P-1605	10 pc. / 80 pc.	32x5/4"
26P-2004	10 pc. / 80 pc.	20x1/2"
26P-2005	10 pc. / 70 pc.	20x3/4"
26P-2605	5 pc. / 50 pc.	26x3/4"
26P-2606	5 pc. / 40 pc.	26x1"
26P-3206*	5 pc. / 25 pc.	32x1"

*\*TILL EXHAUSTION OF STOCK*

## Type: 26P-Z



**Press fitting swivel adapter**  
**Aansluiting met wartel, vlakke dichting**  
**Raccord à visser, joint plat**  
**Pressfitting mit IG flachdichtend ohne Nippel**

Article number	Bag / Box	Type
26P-16Z03	10 pc. / 150 pc.	16x3/8"
26P-16Z04	10 pc. / 150 pc.	16x1/2"
26P-16Z05	10 pc. / 80 pc.	16x3/4"
26P-20Z04	10 pc. / 150 pc.	20x1/2"
26P-20Z05	10 pc. / 70 pc.	20x3/4"
26P-26Z05	5 pc. / 50 pc.	26x3/4"
26P-26Z06	5 pc. / 40 pc.	26x1"
26P-32Z06	5 pc. / 40 pc.	32x1"
26P-32Z07	5 pc. / 40 pc.	32x5/4"

## Type: 26P-Z-DZR (CW602N)



**Press fitting swivel adapter CW602N**  
**Aansluiting met wartel, vlakke dichting CW602N**  
**Raccord à visser, joint plat CW602N**  
**Pressfitting mit IG flachdichtend ohne Nippel CW602N**

Article number	Bag / Box	Type
26P-16Z04DZR	10 pc. / 150 pc.	16x1/2"
26P-20Z04DZR	10 pc. / 150 pc.	20x1/2"
26P-20Z05DZR	10 pc. / 70 pc.	20x3/4"
26P-26Z05DZR	5 pc. / 50 pc.	26x3/4"

## Type: N



**Nipple for article 26P-Z**  
**Nippel voor artikel 26P-Z**  
**Nipple pour article 26P-Z**  
**Nippel für Artikel 26P-Z**

Article number	Bag / Box	Type
N04	10 pc. / 250 pc.	3/4"x3/4"
N05	10 pc. / 200 pc.	3/4 x 3/4
N06	25 pc. / 250 pc.	1"x1"



## Type: 27P



Elbow 45°  
Knie 45°  
Coude 45°  
Winkel 45°

Article number	Bag / Box	Type
27P-2626	5 pc. / 50 pc.	26x26
27P-3232	5 pc. / 30 pc.	32x32

## Type: 28P



Double backplate elbow female, build up  
Dubbele muurplaat binnendraad, opbouw  
Culasse double pour sanitaire femelle  
Sanitär Wandscheibe doppelt IG, Oberbau

Article number	Bag / Box	Type
28P-14041604-1	1 pc. / 20 pc.	14x1/2" - 16x1/2"
28P-16041604-1	1 pc. / 20 pc.	16x1/2" - 16x1/2"

## Type: 28PV



Double backplate elbow female, build-in  
Dubbele muurplaat binnendraad, inbouw  
Culasse double surélevé  
Wandwinkel doppelt erhöht

Article number	Bag / Box	Type
28PV-16031603-1	1 pc. / 15 pc.	16x3/8" - 16x3/8"
28PV-16041604-1	1 pc. / 15 pc.	16x1/2" - 16x1/2"

## Type: 28PF

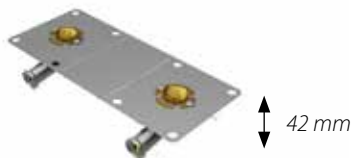

Double backplate elbow female for plaster  
Dubbel muurplaat binnendraad voor gips  
Culasse double femelle pour plâtre  
Wandscheibe doppelt IG für Gips

Article number	Bag / Box	Type
28PF-16041604	1 pc. / 15 pc.	16x1/2" - 16x1/2"
28PF-20042004	1 pc. / 15 pc.	20x1/2" - 20x1/2"

1

2

3

4

5

6

7

8

9

10

11

12



## Henco Brass Press

Henco Brass Press Fittings

### Type: 29P-CS (CW724 R)



Press-fit adapter with copper pipe (CW724)  
 Persfitting verlengd met koperbuis (CW724)  
 Manchon à sertir avec tube en cuivre (CW724)  
 Pressfitting mit Kupferrohr (CW724)

Article number	Bag / Box	Type
29P-1612-CS	10 pc. / 120 pc.	16x12
29P-1615-CS	10 pc. / 120 pc.	16x15
29P-2018-CS	10 pc. / 70 pc.	20x18
29P-2022-CS	10 pc. / 70 pc.	20x22
29P-2622-CS	10 pc. / 70 pc.	26x22

### Type: 30P



Press-fit adapter to copper compression  
 Overgangsstuk Henco pers x koperbuis knelkoppeling  
 Manchon à sertir x tube en cuivre manchon à visser  
 Pressfitting x Klemmverbinder für Kupferrohr

Article number	Bag / Box	Type
30P-1614S*	10 pc. / 120 pc.	16x14
30P-1615S-2	2 pc. / 100 pc.	16x15
30P-2022S	10 pc. / 100 pc.	20x22
30P-2622S	10 pc. / 80 pc.	26x22

*\*TILL EXHAUSTION OF STOCK*

### Type: 31P



Double crossover tee  
 Kruisingsvrij T-stuk  
 Double T croisé  
 Kreuzungs-T-Stück

Article number	Bag / Box	Type
31P-161616	1 pc. / 20 pc.	16x16x16
31P-201616	1 pc. / 20 pc.	20x16x16
31P-201620	1 pc. / 20 pc.	20x16x20
31P-202020	1 pc. / 20 pc.	20x20x20

### Type: ISO-BOX



Insulation box for double crossover tee  
 Isolatiebox voor kruisingsvrij T-Stuk  
 Boîte d'isolation pour T croisé  
 Isolierboxen für Kreuzungs-T-Stück

Article number	Bag / Box	Type
ISO-BOX	1 pc. / 320 pc.	124x124x55mm





## Type: 33P



Nickel plated press-fit adapter to eurocone, 90°  
 Aansluiting met wartel en euroconus-koppeling vernikkeld, 90°  
 Raccord à visser eurocone nickelé, 90°  
 Anschlussverschraubung mit Eurokonus vernickelt, 90°

Article number	Bag / Box	Type
33P-1605	10 pc. / 60 pc.	16x3/4"

## Type: 34P



Henco press swivel adapter with flat sealing, 90°  
 Aansluiting met wartel vlakdichtend, 90°  
 Raccord à visser joint plat, 90°  
 Anschlussverschraubung mit AG flachdichtend, 90°

Article number	Bag / Box	Type
34P-1604	10 pc. / 120 pc.	16x1/2"
34P-3206	5 pc. / 40 pc.	32x1"

## Type: 34P-CS (CW724 R)



Henco press swivel adapter with flat sealing, 90° (CW724 R)  
 Aansluiting met wartel vlakdichtend, 90° (CW724 R)  
 Raccord à visser joint plat, 90° (CW724 R)  
 Anschlussverschraubung mit AG flachdichtend, 90° (CW724 R)

Article number	Bag / Box	Type
34P-1605-CS	10 pc. / 120 pc.	16x3/4"
34P-2004-CS	10 pc. / 80 pc.	20x1/2"
34P-2005-CS	10 pc. / 80 pc.	20x3/4"
34P-2605-CS	10 pc. / 70 pc.	26x3/4"

## Type: 35P



Press-fit adapter to copper press (M-profile)  
 Overgangstuk Henco pers naar koper pers (M-profiel)  
 Manchon à sertir vers cuivre à sertir (profil M)  
 Pressfitting Henco zu Pressfitting für Kupferrohr (M-profile)

Article number	Bag / Box	Type
35P-1615P*	10 pc. / 150 pc.	16x15
35P-2022P*	10 pc. / 80 pc.	20x22

\* TILL EXHAUSTION OF STOCK



# Henco Brass Press

Henco Brass Press Fittings

## Type: 36P (CW724 R)



Press-fit adapter to copper press (V, M & SA profile)  
 Overgangsstuk Henco pers naar koper pers (V, M & SA profiel)  
 Manchon à sertir Henco vers cuivre à sertir (profil M, V & SA)  
 Pressfitting Henco zu Pressfitting für Kupferrohr (Presskontur M, V & SA)

Article number	Bag / Box	Type
36P-1612P	10 pc. / 160 pc.	16x12Cu
36P-1614P	10 pc. / 150 pc.	16x14Cu
36P-1615P	10 pc. / 150 pc.	16x15Cu
36P-1616P	10 pc. / 150 pc.	16x16Cu
36P-2015P	10 pc. / 120 pc.	20x15Cu
36P-2018P	10 pc. / 120 pc.	20x18Cu
36P-2022P	10 pc. / 80 pc.	20x22Cu
36P-2622P	10 pc. / 70 pc.	26x22Cu
36P-2628P	10 pc. / 70 pc.	26x28Cu
36P-3228P	5 pc. / 50 pc.	32x28Cu

## Type: 37P



Press-fit adapter to copper pipe, elbow  
 Persfitting verlengd met koperbuis, knie  
 Coude à sertir avec tube en cuivre soudé  
 Pressfitting mit geschweisstem Kupferrohr, Winkel

Article number	Bag / Box	Type
37P-1412L	10 pc. / 60 pc.	14x12 (227/200mm)
37P-1612L	10 pc. / 40 pc.	16x12 (227/200mm)
37P-1615L	10 pc. / 40 pc.	16x15 (227/200mm)

## Type: 39P



Double bend for radiator nickel-plated 300 mm copper pipe Ø15, connected end  
 Dubbele radiatorbocht koperbuis Ø15, 300 mm, vernikkeld, doorverbonden einde  
 Double courbe radiateur nickelé 300 mm tube en cuivre Ø15, bout rattaché  
 Doppelter Heizkörperwinkel vernickelt 300 mm Kupferrohr Ø15, durchgestelltes Ende

Article number	Bag / Box	Type
39P-160450	1 pc. / 8 pc.	16x1/2" (AS = 50 mm)

*Interaxis 50 mm*

## Type: 40P



Press-fit elbow to copper compression  
 Knie Henco pers x koperbuis knelkoppeling  
 Coude à sertir x tube en cuivre manchon à visser, 90°  
 Winkel Henco Press x Klemmverbinder für Kupferrohr

Article number	Bag / Box	Type
40P-1615S	10 pc. / 60 pc.	16x15 Cu
40P-2022S	10 pc. / 60 pc.	20x22 Cu
40P-2622S	10 pc. / 60 pc.	26x22 Cu



## Type: 41P



Brass press coupling for valve F-connection  
 Messing perskoppeling voor F-aansluiting  
 Connecteur F en laiton  
 Pressfittung für F-Connection

Article number	Bag / Box	Type
41P-16	10 pc. / 40 pc.	16
41P-20	10 pc. / 40 pc.	20
41P-26	10 pc. / 40 pc.	26

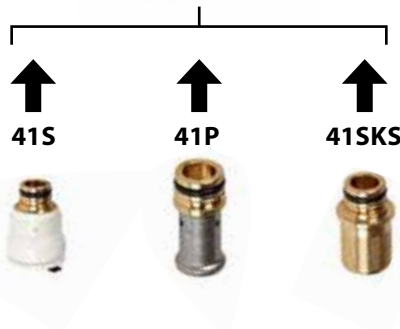

## Type: 42P



Straight coupling PEX  
 Doorverbinder recht PEX  
 Manchon PEX  
 Kupplung PEX

Article number	Bag / Box	Type
42P-161615	10 pc. / 200 pc.	16x2 - 16x1,5
42P-202019	10 pc. / 140 pc.	20x2 - 20x1,9

## Type: 43P



T-piece Henco press 16mm x compression 15mm x press 16mm  
 T-stuk Henco pers 16mm x koper knel 15mm x Henco pers 16mm  
 Piece en T Henco sertir 16mm x machon à visser 15mm x Henco sertir 16mm  
 T-stuck Henco press 16mm x Klemmverbinder 15mm x press 16mm

Article number	Bag / Box	Type
43P-161516	2 pc. / 50 pc.	16x15x16

- 1
- 2
- 3
- 4
- 5
- 6
- 7
- 8
- 9
- 10
- 11
- 12



## Henco Brass Press

Henco Brass Press Fittings

### 1 Type: 44P



Bend 90° female connection toilet reservoir  
Aansluitbocht inbouwreservoir toilet  
Coude 90° femelle connexion réservoir toilet  
Winkel 90° IG Anschluss Reservoir-Toilette

Article number	Bag / Box	Type
44P-1604	10 pc. / 60 pc.	16x1/2"

2

3

4

5

6

7

8

9

### 9 Type: 45P



Straight connection female toilet reservoir  
Rechte aansluiting binnendraad toiletreservoir  
Raccord droit femelle réservoir toilet  
Anschluss IG Reservoir-Toilette

Article number	Bag / Box	Type
45P-1604	10 pc. / 150 pc.	16x1/2"

10

11

12

### Type: 52P



Easy mounting/repair fitting  
Eenvoudige montage/reparatie fitting  
Raccord montage/réparation facile  
Einfache Montage/Reparatur Fitting

Article number	Bag / Box	Type
52P16	1 pc. / 40 pc.	16x16
52P20	1 pc. / 30 pc.	20x20
52P26	1 pc. / 30 pc.	26x26
52P32	1 pc. / 20 pc.	32x32

for ø40, 50 and 63: chapter 2, type 53PK



## Type: WALL BOX



Wall Box - press  
 Wall Box - pers  
 Wall Box - sertir  
 Wall Box - Press

Article number	Box / Big Box	Type
WBP-1604-BL	10 pc. / 300 pc.	16x1/2" blue
WBP-1604-RO	10 pc. / 300 pc.	16x1/2" red
WBP-2004-BL	10 pc. / 300 pc.	20x1/2" blue
WBP-2004-RO	10 pc. / 300 pc.	20x1/2" red

*Without mounting bracket 'WB-PLATE'*



*Instruction video*

## Type: WB-PLATE

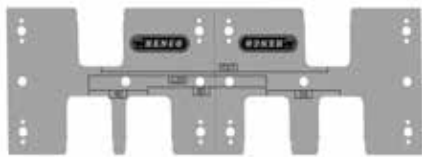

Wall Box mounting bracket  
 Wall Box montage plaat  
 Wall Box plaque de montage  
 Wall Box Montage Bügel

Article number	Box / Outer Box	Type
WBPL-X	10 pc. / 60 pc.	GALV. STEEL

## Type: P-PIESTOP



Stop end press for pipe  
 Eindstop voor buis Pers  
 Bouchon à sertir pour tube  
 Endkappe Press für Rohre

Article number	Bag / Box	Type
P-PIESTOP16	10 pc. / 250 pc.	16x2
P-PIESTOP20	10 pc. / 200 pc.	20x2
P-PIESTOP26	10 pc. / 120 pc.	26x3
P-PIESTOP32	10 pc. / 70 pc.	32x3

1

2

3

4

5

6

7

8

9

10

11

12



## Henco Brass Press

Henco Brass Press Fittings GAS

1 *Gas: only allowed in countries where a HENCO GAS testing + certificate is available! (see [www.henco.be](http://www.henco.be))*  
 2 *Gas: enkel toegelaten in landen waar er een HENCO GAS keur is + een certificaat voorhanden is! (zie [www.henco.be](http://www.henco.be))*  
 3 *Gaz: seulement permis dans des pays où le contrôle a eu lieu + certificat est disponible! (Consultez [www.henco.be](http://www.henco.be))*  
 4 *Gas: nur zugelassen in Länder wo HENCO GAS Prüfung geschehen ist + Zertifikat vorhanden ist! (Siehe [www.henco.be](http://www.henco.be))*

5 Henco brass press fittings for gas in combination with standard pipes gas, see page 23

### 6 Type: 1PG



7 **Elbow 90°**  
 8 **Knie 90°**  
 9 **Coude 90°**  
 10 **Winkel 90°**

Article number	Bag / Box	Type
1PG-1616	10 pc. / 150 pc.	16x16
1PG-2020	10 pc. / 80 pc.	20x20
1PG-2626	5 pc. / 50 pc.	26x26
1PG-3232	5 pc. / 30 pc.	32x32

### 11 Type: 2PG

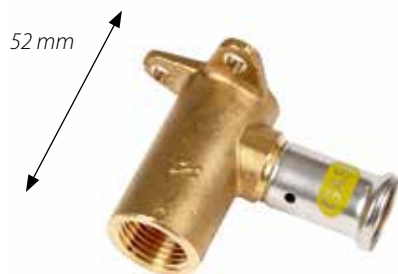

12 **Backplate elbow female**  
**Muurplaat binnendraad**  
**Culasse femelle**  
**Wandscheibe IG**

Article number	Bag / Box	Type
2PG-1604	10 pc. / 50 pc.	16x1/2"
2PG-2004	10 pc. / 50 pc.	20x1/2"
2PG-2005	10 pc. / 50 pc.	20x3/4"
2PG-2605	5 pc. / 50 pc.	26x3/4"

### Type: 2PG-K

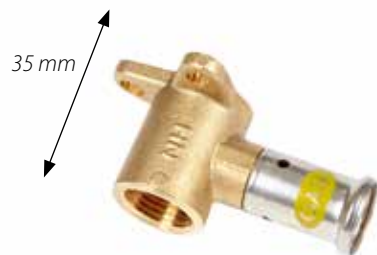

**Backplate elbow female, short model**  
**Muurplaat binnendraad, laag**  
**Culasse femelle, modèle court**  
**Wandscheibe IG, kurzes Modell**

Article number	Bag / Box	Type
2PG-1604K	10 pc. / 50 pc.	16x1/2"



## Type: 5PG



Elbow 90° male adapter  
Knie 90° buitendraad  
Coude 90° mâle  
Winkel 90° AG

Article number	Bag / Box	Type
5PG-1604	10 pc. / 150 pc.	16x1/2"
5PG-2004	10 pc. / 100 pc.	20x1/2"
5PG-2005	10 pc. / 80 pc.	20x3/4"
5PG-2605	10 pc. / 60 pc.	26x3/4"

## Type: 6PG



Elbow 90° female adapter  
Knie 90° binnendraad  
Coude 90° femelle  
Winkel 90° IG

Article number	Bag / Box	Type
6PG-1604	10 pc. / 120 pc.	16x1/2"
6PG-2004	10 pc. / 120 pc.	20x1/2"
6PG-2005	10 pc. / 50 pc.	20x3/4"
6PG-2605	5 pc. / 50 pc.	26x3/4"

## Type: 9PG



T-piece Gas  
T-Stuk Gas  
Pièce T Gaz  
T-Stück Gas

Article number	Bag / Box	Type
9PG-161616	10 pc. / 60 pc.	16x16x16
9PG-202020	10 pc. / 50 pc.	20x20x20
9PG-262626	5 pc. / 30 pc.	26x26x26
9PG-323232*	1 pc. / 20 pc.	32x32x32

\*TILL EXHAUSTION OF STOCK



# Henco Brass Press

Henco Brass Press Fittings GAS

## 1 Type: 10PG



T-reduced centre  
T-verlopend  
Pièce en T réduit  
T-reduziert

Article number	Bag / Box	Type
10PG-201620	10 pc. / 50 pc.	20x16x26
10PG-262026	5 pc. / 30 pc.	26x20x26

## 2 3 4 5 6 7 8 9 Type: 11PG



T-branch and line reduced  
T-2x verlopend  
Pièce en T 2x réduit  
T-2x reduziert

Article number	Bag / Box	Type
11PG-201616*	10 pc. / 50 pc.	20x16x16

*\*TILL EXHAUSTION OF STOCK*

## 10 11 12 Type: 13PG



T-female centre  
T-binnendraad  
Pièce en T femelle  
T-IG

Article number	Bag / Box	Type
13PG-200420	10 pc. / 50 pc.	20x1/2"x20
13PG-260426	5 pc. / 30 pc.	26x1/2"x26





## Type: 15PG



**Straight coupling**  
**Perssok**  
**Manchon**  
**Kupplung**

Article number	Bag / Box	Type
15PG-1616	10 pc. / 200 pc.	16x16
15PG-2020	10 pc. / 140 pc.	20x20
15PG-2626	5 pc. / 80 pc.	26x26
15PG-3232	5 pc. / 50 pc.	32x32

## Type: 16PG



**Reducing coupling**  
**Verloopstuk**  
**Réduction**  
**Kupplung-reduziert**

Article number	Bag / Box	Type
16PG-2016	10 pc. / 150 pc.	20x16
16PG-2620	5 pc. / 80 pc.	26x20
16PG-3226	5 pc. / 40 pc.	32x26

## Type: 17PG



**Straight male adapter**  
**Puntstuk**  
**Raccord droit mâle**  
**Übergangsfitting AG**

Article number	Bag / Box	Type
17PG-1604	10 pc. / 150 pc.	16x1/2"
17PG-2004	10 pc. / 150 pc.	20x1/2"
17PG-2005	10 pc. / 150 pc.	20x3/4"
17PG-2605	5 pc. / 80 pc.	26x3/4"
17PG-2606	5 pc. / 80 pc.	26x1"
17PG-3206	5 pc. / 50 pc.	32x1"

1

2

3

4

5

6

7

8

9

10

11

12



## Henco Brass Press

Henco Brass Press Fittings GAS

### Type: 18PG



**Straight female adapter**  
**Schroefbus**  
**Raccord droit femelle**  
**Übergangsfitting IG**

Article number	Bag / Box	Type
18PG-1604	10 pc. / 150 pc.	16x1/2"
18PG-2004	10 pc. / 100 pc.	20x1/2"
18PG-2005	10 pc. / 100 pc.	20x3/4"
18PG-2605	5 pc. / 80 pc.	26x3/4"
18PG-2606	5 pc. / 70 pc.	26x1"
18PG-3206	5 pc. / 50 pc.	32x1"

### Type: 30PG



**Press-fit adapter to copper press compression**  
**Overgangstuk Henco pers x koperbuis knelkoppeling**  
**Manchon à sertir Henco vers tube de cuivre manchon à visser**  
**Pressfitting x Klemmverbinder für Kupferrohr**

Article number	Bag / Box	Type
30PG-1615S-2	2 pc. / 100 pc.	16x15
30PG-2022S	10 pc. / 100 pc.	20x22
30PG-2622S	10 pc. / 80 pc.	26x22

### Type: 36PG



**Press-fit adapter to copper press (V, M & SA profile)**  
**Overgangstuk Henco pers naar koper pers (V, M & SA profiel)**  
**Manchon à sertir Henco vers cuivre à sertir (profil M, V & SA)**  
**Pressfitting Henco zu Pressfitting für Kupferrohr (CuSi)**

Article number	Bag / Box	Type
36PG-1615P	10 pc. / 150 pc.	16x15Cu
36PG-2015P	10 pc. / 120 pc.	20x15Cu
36PG-2022P	10 pc. / 120 pc.	20x22Cu
36PG-2615P	10 pc. / 100 pc.	26x15Cu
36PG-2622P	10 pc. / 100 pc.	26x22Cu





# Henco Brass Compression

Henco Brass Compression Fittings

## Type: 1



**Straight male adapter**  
**Puntstuk**  
**Raccord droit mâle**  
**Kupplung AG**

Article number	Bag / Box	Type
1-1403C-S**	10 pc. / 250 pc.	14x3/8"
1-1604-S	10 pc. / 250 pc.	16x1/2"
1-1804-S	10 pc. / 150 pc.	18x1/2"
1-1805*	10 pc. / 150 pc.	18x3/4"
1-2004-S	10 pc. / 120 pc.	20x1/2"
1-2004-ZS	10 pc. / 120 pc.	20x1/2"
1-2005-S	10 pc. / 150 pc.	20x3/4"
1-2605-S	5 pc. / 80 pc.	26x3/4"
1-2606-S	5 pc. / 80 pc.	26x1"
1-3206-S	5 pc. / 50 pc.	32x1"

*\*TILL EXHAUSTION OF STOCK*

*\*\*For fuel oil only*

## Type: 2



**Straight coupling**  
**Doorverbinder recht**  
**Manchon**  
**Kupplung doppelt**

Article number	Bag / Box	Type
2-1616-S	10 pc. / 200 pc.	16x16
2-2020-S	10 pc. / 120 pc.	20x20

## Type: 3



**Straight female adapter**  
**Schroefbus**  
**Raccord droit femelle**  
**Kupplung IG**

Article number	Bag / Box	Type
3-1604-S	10 pc. / 200 pc.	16x1/2"
3-1804-S	10 pc. / 120 pc.	18x1/2"
3-2004-S	10 pc. / 120 pc.	20x1/2"
3-2005-S	10 pc. / 120 pc.	20x3/4"
3-2605-S	5 pc. / 60 pc.	26x3/4"
3-2606-S	5 pc. / 50 pc.	26x1"

## Type: 4



**Elbow 90°**  
**Knie 90°**  
**Coude 90° mâle**  
**Winkel 90°**

Article number	Bag / Box	Type
4-1616-S	10 pc. / 150 pc.	16x16
4-2020-S	10 pc. / 60 pc.	20x20
4-2626-S	5 pc. / 40 pc.	26x26

# Henco Brass Compression

Henco Brass Compression Fittings



## Type: 5



**Elbow 90° male adapter**  
**Knie 90° buitendraad**  
**Coude 90° mâle**  
**Winkel 90° AG**

Article number	Bag / Box	Type
5-1804*	10 pc. / 150 pc.	18x1/2"
5-1604-S	10 pc. / 150 pc.	16x1/2"
5-2005-S	10 pc. / 100 pc.	20x3/4
5-2606-S	5 pc. / 40 pc.	26x1

*\*TILL EXHAUSTION OF STOCK*

## Type: 6



**Elbow 90° female adapter**  
**Knie 90° binnendraad**  
**Coude 90° femelle**  
**Winkel 90° IG**

Article number	Bag / Box	Type
6-1604-S	10 pc. / 150 pc.	16x1/2"
6-1804*	10 pc. / 90 pc.	18x1/2"
6-2004-S	10 pc. / 80 pc.	20x1/2"
6-2005-S	10 pc. / 80 pc.	20x3/4"

*\*TILL EXHAUSTION OF STOCK*

## Type: 7



**Backplate elbow with branch connection**  
**Sanitair muurplaat binnendraad**  
**Culasse pour sanitaire femelle**  
**Sanitär Wandscheibe**

Article number	Bag / Box	Type
7-1604-S	10 pc. / 80 pc.	16x1/2"

## Type: 8



**T-piece**  
**T-stuk**  
**Pièce en T**  
**T-Stück**

Article number	Bag / Box	Type
8-161616-S	10 pc. / 80 pc.	16x16x16

## Type: 10



**Nut, insert and jointing ring**  
**Moer, insert en klemring**  
**Ecrou, insert et bicône**  
**Mutte, Stuthülse und Klemmring**

Article number	Bag / Box	Type
10-1604SN*	10 pc. / 300 pc.	16x1/2

*\*TILL EXHAUSTION OF STOCK*



## Henco Brass Compression

Henco Brass Compression Fittings

### Type: 13-2



**Nut, insert and jointing ring to copper compression**  
**Adapter Henco buis naar messing knelverbinding**  
**Raccord à visser cuivre vers multicouche**  
**Verbindungsstück Kupfer Schraubfitting auf Henco**

Article number	Bag / Box	Type
13-1415-2*	2 pc. / 150 pc.	14x15 Cu
13-1615A-2*	2 pc. / 150 pc.	16x15 Cu
13-1615HA-2	2 pc. / 150 pc.	16x15 Cu
13-2022HA-2	2 pc. / 100 pc.	20x22 Cu
13-2628H-2	2 pc. / 80 pc.	26x28 Cu

*\*Nickel plated nut*

### Type: 13-VH



**Adapter for Henco compression to copper compression**  
**Adapter Henco buis naar messing knelverbinding**  
**Adapteur raccord à visser cuivre vers multicouche**  
**Verbindungsstück für Henco Schraubfitting auf Kupfer Schraubfitting**

Article number	Bag / Box	Type
13-V2622H-2	2 pc. / 50 pc.	26x22 Cu

### Type: 24



**Compression coupling Henco x copper tube**  
**Overgangsstuk Henco knel x koperbuis knelverbinding**  
**Raccord droit Henco x tube de cuivre manchon à visser**  
**Gerade Fitting Henco x Klemmverbinder für Kupferrohr**

Article number	Bag / Box	Type
24-1615-S	10 pc. / 200 pc.	16x15
24-2022	10 pc. / 100 pc.	20x22
24-2622*	5 pc. / 50 pc.	26x22

*\*TILL EXHAUSTION OF STOCK*

### Type: EK



**Nickel plated eurocone (3/4" F)**  
**Euroconus schroefkoppeling (3/4" F)**  
**Raccord à visser eurocone (3/4" F)**  
**Schraubfitting Eurokonus (3/4" F)**

Article number	Bag / Box	Type
EK12-2	2 pc. / 100 pc.	Ø12x3/4"
EK14-2	2 pc. / 100 pc.	Ø14x3/4"
EK16-2	2 pc. / 100 pc.	Ø16x3/4"
EK17-2	2 pc. / 100 pc.	Ø17x3/4"
EK18-2	2 pc. / 100 pc.	Ø18x3/4"
EK20-2	2 pc. / 100 pc.	Ø20x3/4"

# Henco Brass Compression

Henco Brass Compression Fittings



## Type: EK15



Eurocone (3/4" F) for copper tube 15mm  
Euroconus-schroefkoppeling (3/4" F) voor koperbuis 15mm  
Raccord à visser eurocone (3/4" F) pour tube de cuivre 15mm  
Schraubfitting Eurokonus (3/4") für Kupferrohr 15mm

Article number	Box / Big Box	Type
EK15	25 pc. / 300 pc.	Ø15x3/4" EK

## Type: SPLIT



Split olive for eurocone  
Henco Klemring voor EK  
Anneau de serrage pour raccordement eurocone  
Klemring für EK

Article number	Bag	Type
SPLIT-14	10 pc.	Ø14
SPLIT-16	10 pc.	Ø16
SPLIT-20	10 pc.	Ø20

## Type: SPLIT-S



Henco Split ring for compression fittings (not for EK)  
Henco Klemring voor schroeffitting (Niet voor EK'S)  
Anneau de serrage pour raccords à visser (pas pour EK)  
Klemring für Schraubfitting (nicht für EK)

Article number	Bag	Type
SPLIT-S16	10 pc.	Ø16
SPLIT-S20	10 pc.	Ø20
SPLIT-S26	10 pc.	Ø26

## Type: AB



Elbow 90° eurocone elbow (3/4" M)  
Knie 90° voor euroconus-aansluiting (3/4" M)  
Coude 90° pour raccordement eurocone (3/4" M)  
Winkel 90° für Eurokonusanschluß (3/4" M)

Article number	Bag / Box	Type
AB1420*	10 pc. / 100 pc.	14x20

\*TILL EXHAUSTION OF STOCK

## Type: ABE



Elbow 90° eurocone (3/4" M) x 1/2" male adapter  
Knie 90° buitendraad 1/2" x euroconus-aansluiting (3/4" M)  
Coude 90° mâle 1/2" x raccordement eurocone (3/4" M)  
Winkel 90° AG 1/2 x Eurokonusanschluss (3/4" M)

Article number	Bag / Box	Type
ABEK04*	10 pc. / 150 pc.	1/2"x3/4" for EK

\*TILL EXHAUSTION OF STOCK



# Henco Brass Compression

Henco Brass Compression Fittings

## Type: AT



**Eurocone equal T-piece**  
**T-stuk voor euroconus-aansluiting (3/4" M)**  
**Pièce en T pour raccordement eurocone (3/4" M)**  
**T-Stück für Eurokonusanschluß (3/4" M)**

Article number	Bag / Box	Type
AT1420*	10 pc. / 100 pc.	3/4"x3/4"x3/4" for EK

*\*TILL EXHAUSTION OF STOCK*

## Type: AD



**Eurocone straight coupling (3/4" M)**  
**Overgangstuk met 2x euroconus-aansluiting (3/4" M)**  
**Mamelon 2x raccordement eurocone (3/4" M)**  
**Nippel für 2x Eurokonusanschluss**

Article number	Bag / Box	Type
AD-EKEK	10 pc. / 250 pc.	3/4"x3/4" for EK

## Type: AN



**Straight eurocone connection (3/4" M) to 1/2" male adapter**  
**Recht overgangsstuk 1/2" M met O-ring en EK-aansluiting (3/4" M)**  
**Manchon droit mâle 1/2" avec joint torique et eurocone**  
**Nippel AG 1/2" mit O-ring und Eurokonusanschluss (3/4" M)**

Article number	Bag / Box	Type
AN1420	10 pc. / 250 pc.	1/2"x3/4" for EK

## Type: 3EK



**Double backplate elbow female, 2x eurocone connection**  
**Double backplate elbow female, 2x eurocone connection**  
**Culasse double, 2x raccordement eurocone**  
**Wandscheibe doppelt IG, 2x Eurokonusanschluss**

Article number	Bag / Box	Type
3EK-050405	5 pc. / 40 pc.	3/4"x1/2"x3/4"

## Type: WBS



**Wall Box - compression**  
**Wall Box - schroef**  
**Wall Box - compression**  
**Wall Box - Schraub**

Article number	Box / Big Box	Type
WBS-1604-RO	10 pc. / 300 pc.	16x1/2" red
WBS-1604-BL	10 pc. / 300 pc.	16x1/2" blue

*Without mounting bracket WB-plate*



*Instruction video*



# Henco Brass Compression

Henco Brass Compression Fittings



## Type: WB-PLATE

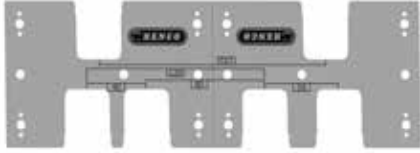

Wall Box mounting bracket  
Wall Box mounting bracket  
Wall Box plaque de montage  
Wall Box Montage Bügel

Article number	Box / Big Box	Type
WBPL-X	10 pc. / 60 pc.	GALV. STEEL

## Type: 2C



Wallplate horizontal 1/2"x1/2"  
Horizontale/rechtdoor muurplaat 1/2"x1/2"  
Culasse horizontale 1/2"x1/2"  
Wandscheibe horizontal 1/2"x1/2"

Article number	Bag / Box	Type
2C-0404	10 pc. / 100 pc.	1/2"

1

2

3

4

5

6

7

8

9

10

11

12



## Henco Manifolds

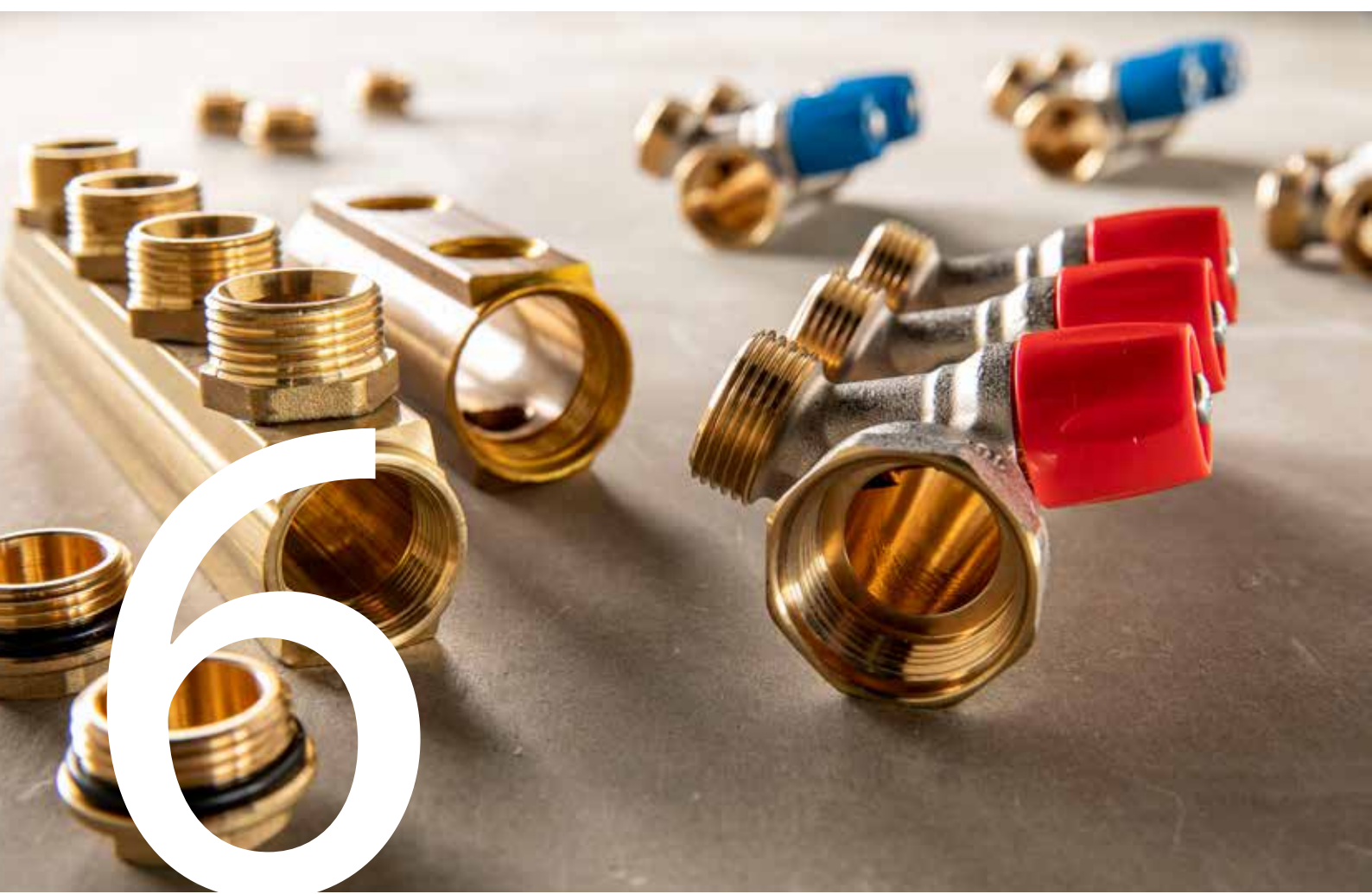

	<i>Page</i>
<i>Henco Full Flow Manifold</i>	<i>99</i>
<i>Henco Brass Manifolds</i>	<i>104</i>



## POSSIBLE COMBINATIONS

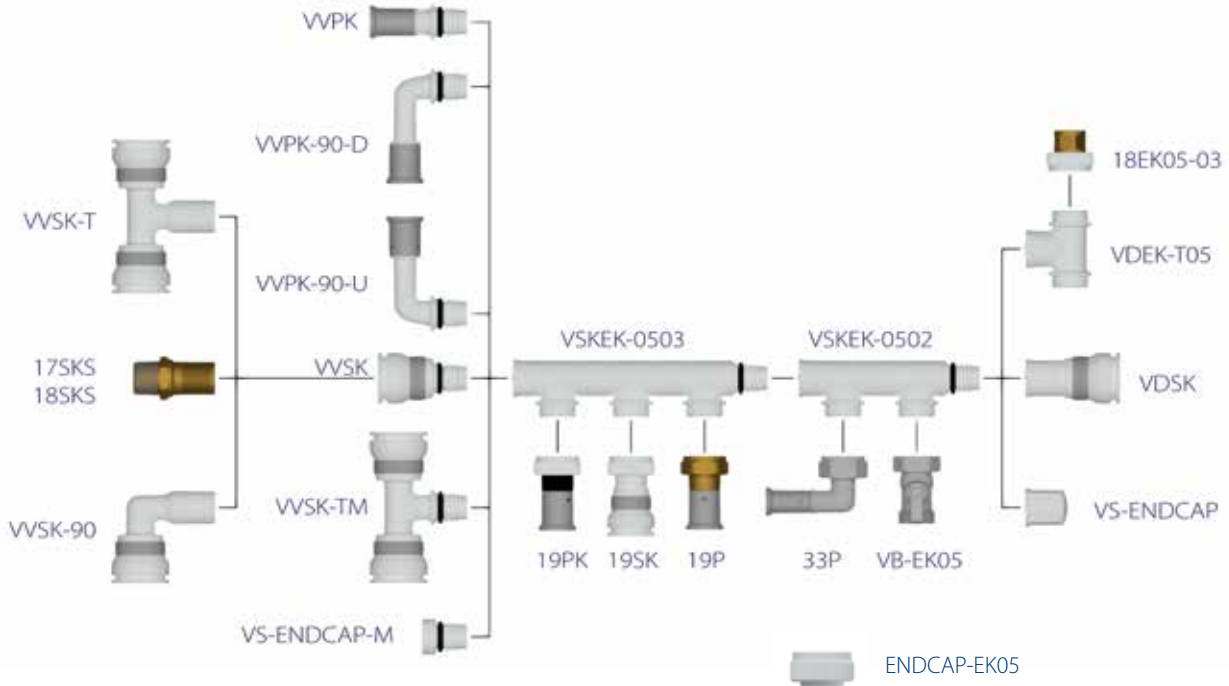

- 1
- 2
- 3
- 4
- 5
- 6
- 7
- 8
- 9
- 10
- 11
- 12

### Type: VSKEK-0502



2-group basic part with 2 eurocone connections 3/4"  
 2-groeps basis deel met 2 euroconus-aansluitingen 3/4"  
 Section de base à 2 groupes avec 2 raccords eurocone 3/4"  
 2-gruppiges Basisprofil mit 2 Eurokonusanschlüssen 3/4"

Article number	Bag / Box	Type
VSKEK-0502	10 pc. / 30 pc.	2x3/4"

### Type: VSKEK-0503

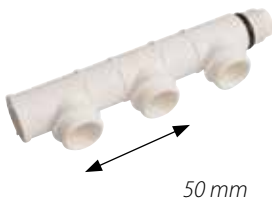

3-group basic part with 3 eurocone connections 3/4"  
 3-groeps basis deel met 3 euroconus-aansluitingen 3/4"  
 Section de base à 3 groupes avec 3 raccords eurocone 3/4"  
 3-gruppiges Basisprofil mit 3 Eurokonusanschlüssen 3/4"

Article number	Bag / Box	Type
VSKEK-0503	10 pc. / 30 pc.	3x3/4"

### Type: 19SK



Push fitting with eurocone connection  
 Steekkoppeling met euroconus-aansluiting  
 Raccord push fit avec eurocone  
 Steckkupplung mit Eurokonus

Article number	Bag / Box	Type
19SK-1505	10 pc. / 80 pc.	15x3/4" EK
19SK-1605	10 pc. / 80 pc.	16x3/4" EK
19SK-2005	10 pc. / 80 pc.	20x3/4" EK



# Henco Manifolds

Henco Full Flow Manifold

## Type: 26SK



Push fitting with swivel and flat sealing  
 Steekkoppeling met wartel en vlakke dichting  
 Raccord push fit avec raccord ecrou etanchéité plate  
 Steckkupplung mit Drehbar und flach Versiegelung

Article number	Bag / Box	Type
26SK-1605*	10 pc. / 80 pc.	16x3/4
26SK-2005*	10 pc. / 80 pc.	20x3/4

*\*TILL EXHAUSTION OF STOCK*

## Type: VVSK



Straight entry piece  
 Voeding voor verdeler  
 Départ collecteur  
 Eingang für Verteiler

Article number	Bag / Box	Type
VVSK-20	10 pc. / 80 pc.	20
VVSK-26	10 pc. / 70 pc.	26

## Type: VVSK-TM



T-piece for supply for Vision manifold  
 Aanvoer T-stuk voor Vision manifold  
 Départ pièce en T collecteur Vision  
 T-Stück für Vorlauf für Vision Verteiler

Article number	Bag / Box	Type
VVSK-T26M26	5 pc. / 20 pc.	26-26
VVSK-T20M20	10 pc. / 30 pc.	20-20

## Type: 17SKS



Straight nipple male  
 Puntstuk  
 Raccord droit mâle  
 Übergangsfitting AG

Article number	Bag / Box	Type
17SKS-2004	5 pc. / 150 pc.	20x1/2"
17SKS-2005	5 pc. / 150 pc.	20x3/4"
17SKS-2604	5 pc. / 100 pc.	26x1/2"
17SKS-2605	5 pc. / 100 pc.	26x3/4"

*Applicable with HENCO Vision fittings & full flow manifolds*

## Type: 18SKS



Straight nipple female  
 Recht aansluitstuk binnendraad  
 Raccord droit femelle  
 Übergangsfitting IG

Article number	Bag / Box	Type
18SKS-2004	5 pc. / 150 pc.	20x1/2"
18SKS-2005	5 pc. / 100 pc.	20x3/4"
18SKS-2604	5 pc. / 100 pc.	26x1/2"
18SKS-2605	5 pc. / 80 pc.	26x3/4"

*Applicable with HENCO Vision fittings & full flow manifolds*



## Type: VVSK-90



Elbow 90° for manifold  
Knie 90° voor verdeler  
Coude 90° pour collecteur  
Winkel 90° für Verteiler

Article number	Bag / Box	Type
VVSK-20-90	10 pc. / 70 pc.	20-90°
VVSK-26-90	10 pc. / 50 pc.	26-90°

## Type: VVSK-T



T-piece for manifold  
T-stuk voor verdeler  
Pièce en T pour collecteur  
T-Stück für Verteiler

Article number	Bag / Box	Type
VVSK-T202020	10 pc. / 40 pc.	20-20-20
VVSK-T262626	10 pc. / 20 pc.	26-26-26

## Type: VS-ENDCAP



Stop end female for manifold  
Eindstop binnendraad voor verdeler  
Bouchon femelle pour collecteur  
Endkappe IG für Verteiler

Article number	Bag / Box	Type
VS-ENDCAP	10 pc. / 180 pc.	F

## Type: 18EK05



Connection for synthetic manifold 3/8"  
Aansluiting voor kunststof verdeler 3/8"  
Raccord à visser eurocone 3/8"  
Verbindung für Verteiler kunststoff 3/8"

Article number	Bag / Box	Type
18EK05-03	2 pc. / 200 pc.	EKx3/8"

## Type: VDEK-T05



T-aansluitstuk voor Verdeler  
T-aansluitstuk voor Verdeler  
T-aansluitstuk voor Verdeler  
T-aansluitstuk voor Verdeler

Article number	Bag / Box	Type
VDEK-T05	10 pc. / 50 pc.	

1

2

3

4

5

6

7

8

9

10

11

12



# Henco Manifolds

Henco Full Flow Manifold

1

## Type: VS-ENDCAP-M

2

3

4

5



Stop end male for manifold  
Eindstop buitendraad voor verdeler  
Bouchon mâle pour collecteur  
Endkappe AG für Verteiler

Article number	Bag / Box	Type
VS-ENDCAP-M	10 pc. / 150 pc.	M

6

## Type: ENDCAP-EK

7

8

9



Stop end eurocone for manifold  
Eindstop euroconus voor verdeler  
Bouchon eurocone pour collecteur  
Endkappe Eurokonus für Verteiler

Article number	Bag / Box	Type
ENDCAP-EK05	10 pc. / 200 pc.	3/4"

10

11

## Type: VDSK

12



Straight female adapter for manifold or manifold extension  
Doorverbinder voor montage op verdeler of verlengstuk  
Manchon pour bout de collecteur  
Ausgang für Verteiler

Article number	Bag / Box	Type
VDSK-20	10 pc. / 80 pc.	20
VDSK-26	10 pc. / 60 pc.	26

## Type: SK-STOPCLIP



Reusable stop and clip for push fit connection  
Herbruikbare stop en clip passend in een steekverbinding  
Bouchon et clip réutilisables pour connection push fit  
Stopfen und clip für Steckanschluss, wieder verwendbar

Article number	Bag / Box	Type
SK-STOPCLIP16	10 pc. / 120 pc.	16
SK-STOPCLIP20	10 pc. / 100 pc.	20
SK-STOPCLIP26	10 pc. / 80 pc.	26



## Type: SK-B05



Bracket for full flow manifolds  
Montagebeugel voor full flow manifolds  
Double support pour full flow manifolds  
Halter für full flow manifolds

Article number	Bag / Box	Type
SK-B05	1 pc. / 100 pc.	B05

## Type: VVPK



Straight entry piece - Press  
Voeding voor verdeler - Pers  
Arrivée pour collecteur - à sertir  
Eingang für verteiler - Press

Article number	Bag / Box	Type
VVPK-20	10 pc. / 80 pc.	20
VVPK-26	10 pc. / 70 pc.	26

## Type: VVPK90-D



Bend entry piece down 90° - press  
Voeding verdeler bocht 90° toevoer onder - pers  
Départ dessous pour collecteur coude 90° - à sertir  
Eingang für Verteiler Winkel 90° nieder - presss Article number Bag / Box T

Article number	Bag / Box	Type
VVPK90-20-D	10 pc. / 70 pc.	20-90° Down
VVPK90-26-D	10 pc. / 50 pc.	26-90° Down

## Type: VVPK90-U



Bend entry piece up 90° - press  
Voeding verdeler bocht 90° graden boven - pers  
Départ par dessus pour collecteur coude 90° - à sertir  
Eingang für Verteiler Winkel 90° oben - press

Article number	Bag / Box	Type
VVPK90-20-U	10 pc. / 70 pc.	20-90° Up
VVPK90-26-U	10 pc. / 50 pc.	26-90° Up



# Henco Manifolds

Henco Brass Manifolds

## Type: VB-EK05



**Ball valve, 2x eurocone connection**  
**Bolkraan, 2x euroconus aansluiting**  
**Vanne d'arrêt, 2x raccordement eurocone**  
**Kugelhahn, 2x Eurokonus**

Article number	Box / Big Box	Type
VB-EK05	25 pc. / 200 pc.	3/4" EK x 3/4" EK

## Type: VB-HANDLE



**Handles for VB-articles**  
**Handvaten voor VB-artikels**  
**Manche pour VB-article**  
**Handgriff für VB-article**

Article number	Bag / Box	Type
VB-HANDLE-RED	1 pc. / 100 pc.	Red
VB-HANDLE-BLUE	1 pc. / 100 pc.	Blue

## Type: VB05



**Manifold 3/4" with ball valves + EK connection**  
**Verdeler 3/4" met bolkraan + EK-uitgangen**  
**Collecteur 3/4" avec vanne à sphère + EK connexion**  
**Verteiler 3/4" mit Kugelhahnset + EK Verbindung**

Article number	Box / Big Box	Type
VB050502-BLAUW	5 pc. / 50 pc.	3/4"x2xEK14,16,18 & 20 blue
VB050502-ROOD	5 pc. / 50 pc.	3/4"x2xEK14,16,18 & 20 red
VB050503-BLAUW	5 pc. / 25 pc.	3/4"x3xEK14,16,18 & 20 blue
VB050503-ROOD	5 pc. / 25 pc.	3/4"x3xEK14,16,18 & 20 red
VB050504-BLAUW	4 pc. / 20 pc.	3/4"x4xEK14,16,18 & 20 blue
VB050504-ROOD	4 pc. / 20 pc.	3/4"x4xEK14,16,18 & 20 red

## Type: VB06



**Manifold 1" with ball valve + EK connections**  
**Verdeler 1" met bolkraan + EK aansluitingen**  
**Collecteur 1" avec vanne à sphère + EK connexion**  
**Verteiler 1" mit Kugelhahnset + EK Verbindung**

Article number	Box / Big Box	Type
VB060502-BLAUW	5 pc. / 40 pc.	1"x2xEK14,16,18 & 20 blue
VB060502-ROOD	5 pc. / 40 pc.	1"x2xEK14,16,18 & 20 red
VB060503-BLAUW	5 pc. / 25 pc.	1"x3xEK14,16,18 & 20 blue
VB060503-ROOD	5 pc. / 25 pc.	1"x3xEK14,16,18 & 20 red
VB060504-BLAUW	4 pc. / 20 pc.	1"x4xEK14,16,18 & 20 blue
VB060504-ROOD	4 pc. / 20 pc.	1"x4xEK14,16,18 & 20 red

## Type: VBS



**Plug M with O-ring VBS Manifold**  
**Blindstop M met O-ring VBS verdeler**  
**Bouchon M pour VBS collecteur avec O-ring**  
**Stopf M für Verteiler VBS mit O-Ring**

Article number	Bag / Box	Type
VBS-05	10 pc. / 250 pc.	3/4"
VBS-06	10 pc. / 250 pc.	1" female





## Type: VBS05



**Manifold 3/4" with valve + EK + O-ring connection/alignment**  
**Verdeler 3/4" met kraan + EK + O-ring aansluiting/uitlijning**  
**Bouchon pour VBS collecteur avec O-ring**  
**Stopf für verteiler VBS mit O-ring**

Article number	Bag / Box	Type
VBS050502-BL	1 pc. / 20 pc.	3/4"x2xEK14,16,18 & 20 blue
VBS050502-RO	1 pc. / 20 pc.	3/4"x2xEK14,16,18 & 20 red
VBS050502-GR*	1 pc. / 20 pc.	3/4"x2xEK14,16,18 & 20 green
VBS050503-BL	1 pc. / 15 pc.	3/4"x3xEK14,16,18 & 20 blue
VBS050503-RO	1 pc. / 15 pc.	3/4"x3xEK14,16,18 & 20 red
VBS050503-GR*	1 pc. / 15 pc.	3/4"x3xEK14,16,18 & 20 green
VBS050504-BL	1 pc. / 10 pc.	3/4"x4xEK14,16,18 & 20 blue
VBS050504-RO	1 pc. / 10 pc.	3/4"x4xEK14,16,18 & 20 red
VBS050504-GR*	1 pc. / 10 pc.	3/4"x4xEK14,16,18 & 20 green

\*Available on demand

## Type: VBS06



**Manifold 1" with valve + EK + O-ring connection/alignment**  
**Verdeler 1" met kraan + EK + O-ring aansluiting/uitlijning**  
**Collecteur 1" avec vanne + EK + O-ring alignement**  
**Verteiler 1" mit Hahne + EK + O-ring Verbindung/Ausrichtung**

Article number	Bag / Box	Type
VBS060502-RO	1 pc. / 20 pc.	1"x2xEK14,16,18 & 20 red
VBS060502-BL	1 pc. / 20 pc.	1"x2xEK14,16,18 & 20 blue
VBS060503-RO	1 pc. / 15 pc.	1"x3xEK14,16,18 & 20 red
VBS060503-BL	1 pc. / 15 pc.	1"x3xEK14,16,18 & 20 blue
VBS060504-RO	1 pc. / 10 pc.	1"x4xEK14,16,18 & 20 red
VBS060504-BL	1 pc. / 10 pc.	1"x4xEK14,16,18 & 20 blue

## Type: VBS-F



**Manifold plug F for VBS manifold**  
**Blindstop F voor VBS verdeler**  
**Bouchon F pour VBS collecteur**  
**Stopf F für Verteiler VBS Article number B**

Article number	Bag / Box	Type
VBS-05F	10 pc. / 250 pc.	3/4" female
VBS-06F	10 pc. / 250 pc.	1" female

## Type: 17VBS



**Straight adapter VBS manifold**  
**Recht aansluitstuk VBS verdeler**  
**Raccord droit VBS collecteur**  
**Übergangsfitting AG VBS Verteiler**

Article number	Bag / Box	Type
17VBS-2005	10 pc. / 100 pc.	20x3/4"
17VBS-2605	5 pc. / 80 pc.	26x3/4"
17VBS-2606	5 pc. / 80 pc.	26x1"

## Type: 6VBS



**Elbow 90° female iron adapter for VBS manifold**  
**Knie 90° voor VBS verdeler**  
**Coude 90° femelle pour collecteur VBS**  
**Winkel 90° IG für VBS Verteiler**

Article number	Bag / Box	Type
6VBS-2005	10 pc. / 50 pc.	20x3/4"
6VBS-2605	5 pc. / 50 pc.	26x3/4"



# Henco Manifolds

Henco Brass Manifolds

## Type: SK-B05



**Bracket for manifolds**  
**Montagebeugel voor verdelers**  
**Double support pour collecteurs**  
**Halter für Verteiler**

Article number	Bag / Box	Type
SK-B05	1 pc. / 100 pc.	B05

## Type: V-06

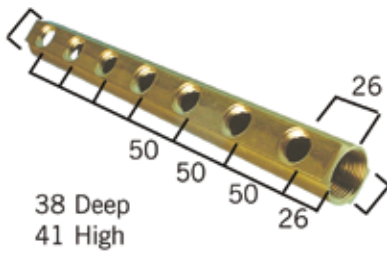

**Manifold 1", 1/2" female thread, 3/8" air vent hole**  
**Verdeler 1", 1/2" aansluitingen, 3/8" ontluichtingsopening**  
**Collecteur 1", connexion 1/2" femelle, connexion 3/8" pour purgeur**  
**Verteiler 1", 1/2" IG, 3/8" Loch für Entlüftung**

Article number	Bag / Box	Type
V-060402*	1 pc. / 8 pc.	1" 2x1/2" x 3/8"
V-060404*	1 pc. / 30 pc.	1" 4x1/2" x 3/8"
V-060405*	1 pc. / 28 pc.	1" 5x1/2" x 3/8"
V-060406*	1 pc. / 30 pc.	1" 6x1/2" x 3/8"

*\*TILL EXHAUSTION OF STOCK*

## Type: V-05-Z

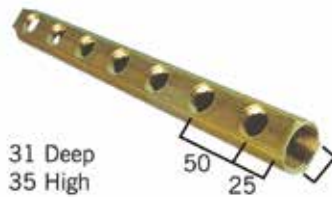

**Manifold 3/4", 1/2" female thread**  
**Verdeler 3/4", 1/2" aansluitingen**  
**Collecteur 3/4", connexion 1/2" femelle**  
**Verteiler 3/4", 1/2" IG**

Article number	Bag / Box	Type
V-050404-Z	1 pc. / 6 pc.	3/4" 4x1/2"

## Type: VEK-06

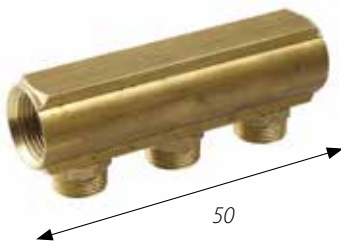

**Manifold 1" with EK connections and one 3/8" air vent hole**  
**Verdeler 1" met EK-aansluitingen en 3/8" ontluichtingsopening**  
**Collecteur 1" avec des raccordements eurocone et un trou 3/8" pour purgeur**  
**Verteiler 1" mit EK-Anschlüssen und 3/8" Loch für Entlüftung**

Article number	Bag / Box	Type
VEK-060502	1 pc. / 48 pc.	1" 2x3/4" x 3/8"
VEK-060503	1 pc. / 32 pc.	1" 3x3/4" x 3/8"
VEK-060504	1 pc. / 20 pc.	1" 4x3/4" x 3/8"
VEK-060505	1 pc. / 21 pc.	1" 5x3/4" x 3/8"
VEK-060507	1 pc. / 15 pc.	1" 7x3/4" x 3/8"
VEK-060508	1 pc. / 15 pc.	1" 8x3/4" x 3/8"

## Type: VEK-06-Z

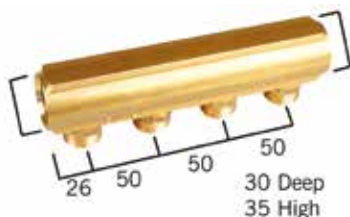

**Manifold 1" with eurocone connections**  
**Verdeler 1" met euroconus-aansluitingen**  
**Collecteur 1" avec des raccordements eurocone**  
**Verteiler 1" mit Eurokonus-Anschlüssen**

Article number	Bag / Box	Type
VEK-060503-Z	1 pc. / 20 pc.	1" 3x3/4"
VEK-060504-Z	1 pc. / 16 pc.	1" 4x3/4"
VEK-060505-Z	1 pc. / 21 pc.	1" 5x3/4"
VEK-060506-Z	1 pc. / 20 pc.	1" 6x3/4"
VEK-060507-Z	1 pc. / 20 pc.	1" 7x3/4"
VEK-060508-Z	1 pc. / 15 pc.	1" 8x3/4"
VEK-060509-Z	1 pc. / 10 pc.	1" 9x3/4"
VEK-060510-Z	1 pc. / 10 pc.	1" 10x3/4"



## Type: H-0212



**Insulated manifold bracket (pairs)**  
**Ophangbeugel dubbel met isolatie voor alle verdelers**  
**Support double avec isolation pour tous les collecteurs**  
**Verteiler-Halter mit Isolierung doppelt für alle Verteiler**

Article number	Bag / Box	Type
H-0212*	2 pc. / 50 pc.	3/4" - 1"

\*Sold per set of 2

## Type: H-0212-S



**Insulated manifold bracket (single)**  
**Ophangbeugel enkel met isolatie voor alle verdelers**  
**Support simple avec isolation pour tous les collecteurs**  
**Verteiler-Halter mit Isolierung einfach für alle Verteiler**

Article number	Bag / Box	Type
H-0212-S	2 pc. / 50 pc.	3/4" - 1"
H-0212-C*	2 pc. / 2x25 pc.	3/4" - 1"

\*Sold per set of 2

## Type: VS REDUCTIE



**Manifold reducer with O-ring**  
**Reductie met O-ring voor verdeler**  
**Réduction avec O-ring pour collecteur**  
**Reduktion für Verteiler mit O-ring**

Article number	Bag / Box	Type
VS-0504	10 pc. / 50 pc.	3/4"x1/2"
VS-0604	10 pc. / 250 pc.	1"x1/2"
VS-0605	10 pc. / 250 pc.	1"x3/4"

## Type: VS BLINDSTOP



**Manifold plug**  
**Blindstop voor verdeler**  
**Bouchon pour collecteur**  
**Stopfen für Verteiler**

Article number	Bag / Box	Type
VS-05	10 pc. / 50 pc.	3/4"
VS-06	10 pc. / 200 pc.	1"
VS-07	10 pc. / 200 pc.	5/4"



## Henco Valves



	<i>Page</i>
<i>Henco Inox Valves</i>	<i>109</i>
<i>Henco Brass Valves</i>	<i>110</i>



## Type: BAP-FFV (press x press) (INOX 316 L)



Inox ball valve with handle, press  
 Inox bolkraan met handvat, pers  
 Vanne en acier inoxydable, presse x presse  
 Kugelhahn aus Edelstahl, Press x Press

Article number	Bag / Box	Type
BAP-FFV1616	1 pc. / 25 pc.	16x16
BAP-FFV2020	1 pc. / 25 pc.	20x20
BAP-FFV2626	1 pc. / 15 pc.	26x26
BAP-FFV3232	1 pc. / 15 pc.	32x32

## Type: BAP-FFV (press x female thread) (INOX 316 L)



Inox ball valve with handle, press x female  
 Inox bolkraan met handvat, pers x vrouwelijk  
 Vanne en acier inoxydable, presse x femelle  
 Kugelhahn aus Edelstahl, Press x IG

Article number	Bag / Box	Type
BAP-FFV1604	1 pc. / 25 pc.	16 x 1/2"
BAP-FFV1805	1 pc. / 25 pc.	18 x 3/4"
BAP-FFV2005	1 pc. / 25 pc.	20 x 3/4"
BAP-FFV2605	1 pc. / 15 pc.	26 x 3/4"
BAP-FFV2606	1 pc. / 15 pc.	26 x 1"
BAP-FFV3207	1 pc. / 10 pc.	32 x 1 1/4"

## Type: BAP-FFV-Z (press x swivel) (INOX 316 L)



Inox ball valve with handle, press x swivel nut  
 Inox bolkraan met handvat, pers x wartelmoer  
 Vanne en acier inoxydable, presse x ecrou  
 Kugelhahn aus Edelstahl, Press x Anschlussverschraubung

Article number	Bag / Box	Type
BAP-FFV16Z05	1 pc. / 25 pc.	16x3/4"
BAP-FFV20Z05	1 pc. / 25 pc.	20x3/4"
BAP-FFV26Z05	1 pc. / 25 pc.	26x3/4"
BAP-FFV26Z06	1 pc. / 15 pc.	26x1"
BAP-FFV32Z06	1 pc. / 15 pc.	32 x 1"

## Type: BAP-FFV-EK (press x eurocone) (INOX 316 L)



Inox ball valve with handle, press x EK  
 Inox bolkraan met handvat, pers x EK  
 Vanne en acier inoxydable, presse x eurocone  
 Kugelhahn aus Edelstahl, Press x Eurokonus

Article number	Bag / Box	Type
BAP-FFV1605EK	1 pc. / 25 pc.	16x3/4" EK
BAP-FFV2005EK	1 pc. / 25 pc.	20x3/4" EK
BAP-FFV2605EK	1 pc. / 15 pc.	26x3/4" EK

- 1
- 2
- 3
- 4
- 5
- 6
- 7
- 8
- 9
- 10
- 11
- 12



# Henco Valves

Henco Brass Valves

## Type: BAP-H



Ball valve with handle, 2x pressfitting  
 Bolkraan met handvat, 2x perskoppeling  
 Vanne d'arrêt à sertir  
 Kugelhahnset mit Handgriff, 2x Pressfitting

Article number	Box / Big Box	Type
BAP-H1616	8 pc. / 80 pc.	16x16
BAP-H2020	8 pc. / 80 pc.	20x20
BAP-H2626	8 pc. / 80 pc.	26x26
BAP-H3232	5 pc. / 25 pc.	32x32

## Type: BAP-SV



Stopvalve DN10  
 Stopbolkraan DN10  
 Vanne d'arrêt DN10  
 Stopvalve DN10

Article number	Bag / Box	Type
BAP-SV1610S	10 pc. / 100 pc.	16 x 10

## Type: VK-EK05



Ball valve, 2 x eurocone connection  
 Bolkraan, 2 x euroconus aansluiting  
 Vanne d'arrêt, 2 x raccordement eurocone  
 Kugelhahn, 2 x Eurokonus

Article number	Box / Big Box	Type
VB-EK05	25 pc. / 200 pc.	3/4" EK x 3/4" EK

## Type: 41S



Brass Vision coupling with valve F-connection  
 Messing Vision koppeling met F-aansluiting  
 Connecteur Vision F  
 Vision Fittung mit F-Verbindung

Article number	Bag / Box	Type
41S-20	10 pc. / 60 pc.	20
41S-26	10 pc. / 80 pc.	26

TILL EXHAUSTION OF STOCK

## Type: 41SKS



Connection Vision coupling with valve F-connection  
 Aansluitstuk Vision koppeling met F-aansluiting  
 Raccord Vision connecteur Vision F  
 Messing Übergang Vision Fittung mit F-Verbindung

Article number	Bag / Box	Type
41SKS-20	10 pc. / 80 pc.	20
41SKS-26	10 pc. / 80 pc.	26

TILL EXHAUSTION OF STOCK

## Type: BA-F41



Built-in Ball Valve Fastec DN15  
 Inbouwbolkraan Fastec DN15  
 Vanne à sphère Fastec DN15  
 Einbau Kugelhahnset Fastec DN15

Article number	Bag / Box	Type
BA-F41	1 pc. / 50 pc.	

TILL EXHAUSTION OF STOCK



- 1
- 2
- 3
- 4
- 5
- 6
- 7
- 8
- 9
- 10
- 11
- 12

## Type: EK15



Eurocone (3/4" F) for copper tube 15mm  
 Euroconus-schroefkoppeling (3/4" F) voor koperbuis 15mm  
 Raccord à visser eurocone (3/4" F) pour tube de cuivre 15mm  
 Schraubfitting Eurokonus (3/4") für Kupferrohr 15mm

Article number	Box / Big Box	Type
EK15	25 pc. / 300 pc.	Ø15x3/4" EK

## Type: RADTH-VL



Thermostatic radiator valve head  
 Thermostatisch regelement met vaste vloeistofvoeler  
 Tête thermostat.à bulbe,équipée d un réglage de temp. limite  
 Thermostatkopf mit festem flüssigkeitsfühler

Article number	Box / Big Box	Type
RADTH-VL*	10 pc. / 150 pc.	THERM

*\*TILL EXHAUSTION OF STOCK*

## Type: RADNI



Nipple for H radiator block  
 Nippel voor H-radiatorblok  
 Vanne pour raccord radiateur (H&V)  
 Nippel für H-Anschluss

Article number	Bag / Box	Type
RADNI-0504	10 pc. / 500 pc.	1/2"x3/4"

## Type: RAD04-100V



Radiator connector with 3/4" eurocone connections, straight  
 Onderblok met 3/4" euroconus-aansluitingen, recht  
 Raccord radiateur, droit, eurocone  
 Heizkörperanschluss 1/2" mit 3/4" Eurokonus-Anschlüssen, unten

Article number	Bag / Box	Type
RAD04-100V	1 pc. / 10 pc.	1/2"x3/4" EK



## Henco Underfloor Heating



	<i>Page</i>
<i><b>Underfloor Heating Systems</b></i>	<i><b>113</b></i>
<i><b>Underfloor Heating Manifolds</b></i>	<i><b>120</b></i>
<i><b>Hencologic Wired</b></i>	<i><b>129</b></i>
<i><b>Hencologic Wireless</b></i>	<i><b>132</b></i>





## Type: UFH-ISOPRO30



System plate with 30mm EPS insulation and 28dB acoustic improvement  
 Noppenplaat met 30mm EPS isolatie, 28dB geluidsverbetering  
 Plaque à plot avec isolation EPS de 30mm, isolant acoustique 28dB  
 Systemplatte mit Dämmung Styropor 30mm, Trittschall verbesserung 28dB

Article number	Multipack	Type
UFH-ISOPRO30	6.72 m2	1400x800mm - 5kPa - 28dB - R 0,75m <sup>2</sup> K/W *Pipe Ø16, centre-to-centre: multiple 50mm hor./ver.

## Type: UFH-ISOPRO11



System plate with 11mm EPS insulation  
 Noppenplaat met 11mm EPS Isolatie  
 Plaque à plot avec isolation EPS de 11mm  
 Systemplatte mit Dämmung Styropor 11mm

Article number	Multipack	Type
UFH-ISOPRO11	14.56 m2	1400x800mm - 75kPa R 0,31m <sup>2</sup> K/W *Pipe Ø16, centre-to-centre: multiple 50mm hor./ver.

## Type: UFH-PRO



System plate without insulation  
 Noppenplaat zonder isolatie  
 Plaque à plot sans isolation  
 Systemplatte ohne Dämmung

Article number	Multipack	Type
UFH-PRO	13.44 m2	1400x800mm - 5kPa *Pipe Ø16, centre-to-centre: multiple 50mm hor./ver.

## Type: UFH-RAS

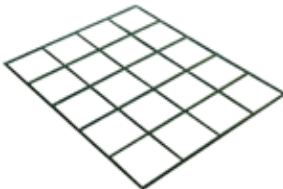

Galvanized steel mesh  
 Stalen draadmat verzinkt  
 Treillis en acier galvanisé  
 Trägermatte aus Eisen verzinkt

Article number	Multipack	Type
UFH-RAS10	25.2 m <sup>2</sup> (10 x 2,52 m <sup>2</sup> )	2,52 m <sup>2</sup> - grid 100x100mm
UFH-RAS15	25.2 m <sup>2</sup> (10 x 2,52 m <sup>2</sup> )	2,52 m <sup>2</sup> - grid 150x150mm
UFH-RAS20	24 m <sup>2</sup> (10 x 2,4 m <sup>2</sup> )	2,4 m <sup>2</sup> - grid 200x200mm

## Type: UFH-RAS-RB3



Connection clip for steel mesh  
 Verbindingsclip voor stalen draadmatten  
 Clip de fixation pour treillis  
 Verbinder für Trägermatte

UFH-RAS-VLE p 156

Article number	Bag / Box	Type
UFH-RAS-RB3	30 pc. / 3.000 pc.	RB

## Type: UFH-RAS-BIND15



UFH-RAS-VLE p 156

Steel strand, plasticized, to connect pipe on steel mesh  
 Stalen vlechtdraad, geplastificeerd, om buis op draadmat te binden  
 Fil de tressage métallique, plastifié, pour fixer tube sur treillis  
 Stahldraht, plastifiziert, für Befestigung der Rohre auf Trägermatte

Article number	Bag	Type
UFH-RAS-BIND15A	250 pc.	160 mm
UFH-RAS-BIND15B	2500 pc.	160 mm



# Henco Underfloor Heating

Underfloor Heating Systems

## Type: UFH-RAS-CLIP



Synthetic clip for steel mesh  
Kunststofclip voor draadmat  
Attache en plastique pour treillis  
Rohrclip für Trägermatte

Article number	Bag / Box	Type
UFH-RAS-CLIP16	200 pc. / 1000 pc	Ø16
UFH-RAS-CLIP18	200 pc. / 1000 pc	Ø18
UFH-RAS-CLIP20*	200 pc. / 1000 pc	Ø20

*\*TILL EXHAUSTION OF STOCK*

## Type: UFH-TACK-KLS



Tacker sheet with EPS insulation, foil with 100 x 100 mm grid marking and overlap  
Tacker klapset met EPS isolatie voorzien van folie met raster 100 x 100 mm en overlap  
Plaque tacker en isolation EPS, film avec trame 100 x 100 mm et rabat  
Verbundplatte aus Styropordämmung mit Folie Masche 100 x 100 mm und Überschneidung

Article number	Multipack	Type
UFH-TACK-KLS20	10 m2 (5 x 2m <sup>2</sup> )	1000x2000x20mm - 4kPa - 28dB R 0,44
UFH-TACK-KLS25	10 m2 (5 x 2m <sup>2</sup> )	1000x2000x25mm - 4kPa - 28dB R 0,56
UFH-TACK-KLS30	10 m2 (5 x 2m <sup>2</sup> )	1000x2000x30mm - 4kPa - 29dB R 0,67
UFH-TACK-KLS40	10 m2 (5 x 2m <sup>2</sup> )	1000x2000x40mm - 4kPa - 30dB R 0,89

## Type: UFH-TACK-38K



UFH-TACK p 155

Tacker clip, 38 mm  
Tackernagel, 38 mm  
Agrafe tacker, 38 mm  
Tackernadel, 38 mm

Article number	Box / Big Box	Type
UFH-TACK-38K	300 pc. / 6000 pc.	38mm

*TILL EXHAUSTION OF STOCK*

## Type: UFH-TACK-40



UFH-TACK p 155

Tacker clip, 40 mm  
Tackernagel, 40 mm  
Agrafe tacker, 40 mm  
Tackernadel, 40 mm

Article number	Box / Big Box	Type
UFH-TACK-40*	300 pc. / 8400 pc.	40mm

*\*Pipe Ø 16 -20*

## Type: UFH-TACK-60



UFH-TACK p 155

Tacker clip, 60 mm  
Tackernagel, 60 mm  
Agrafe tacker, 60 mm  
Tackernadel, 60 mm

Article number	Box / Big Box	Type
UFH-TACK-60	300 pc. / 6000 pc.	60mm

## Type: UFH-SCOTCH-66



Adhesive tape  
Kleefband  
Ruban adhésif  
Klebeband

Article number	Bag / Box	Type
UFH-SCOTCH-66	1 pc. / 48 pc.	66 m



## Type: UFH-DRY-F



Secor EPS panel with milling and alu foil  
 Secor EPS paneel met frezing en aluminium toplaag  
 Paneau Secor en insulation PE avec fraisage et film en alu  
 Secor platte aus Styropordämmung mit Fräsung und ALU folie

Article number	Pallet	Type
UFH-DRY-1617-150F	8.8 m2	1177x750x17 - 150mm - 300 kPa - 0,27m <sup>2</sup> K/W
UFH-DRY-1617-200F	9 m2	1177x800x7 - 200mm - 300 kPa - 0,24m <sup>2</sup> K/W
UFH-DRY-1625-100F	9.4 m2	1177x800x25 - 100mm - 300 kPa - 0,53m <sup>2</sup> K/W
UFH-DRY-1625-150F	8.8 m2	1177x750x25 - 150mm - 300 kPa - 0,60m <sup>2</sup> K/W
UFH-DRY-1625-200F	9 m2	1177x 800x25 - 200mm - 300 kPa - 0,61m <sup>2</sup> K/W
UFH-DRY-1630-150F	9.4 m2	1177x750x30 - 150mm - 300 kPa - 0,75m <sup>2</sup> K/W

## Type: UFH-DRY-FTAPE



SECOR Alu tape 50mmx25m  
 SECOR Alu kleefband 50mmx25m  
 SECOR Bande adhésive aluminium 50mmx25m  
 SECOR ALU Klebeband 50mmx25m

Article number	Bag / Box	Type
UFH-DRY-FTAPE	1 pc. / 36 pc.	25m x 50mm

## Type: UFH-DRY-GLUEF



Secor glue  
 Secor lijm  
 Colle secor  
 Secor Klebstoff

Article number	Box	Type
UFH-DRY-GLUEF	15 pc.	1 KG

## Type: UFH-P18-GP18



Gypsum fibreboard 18mm, round milling for RENO12 system  
 Gipsvezelplaat 18mm, ronde frezing voor RENO12 systeem  
 Plaques en fibro-plâtre 18mm, avec une fraisage circulaire système RENO12  
 Gipsfaserplatte 18mm, runde Fräsung für das RENO12 system

Article number	Multipack	Type
UFH-P18-GP18	1 pc.	1000 x 600 x 18mm

## Type: UFH-P18-GP18V



Gypsum fibreboard 18mm, vertical milling for RENO12 system  
 Gipsvezelplaat 18mm, verticale frezing voor RENO12 systeem  
 Plaques en fibro-plâtre 18mm, système RENO12  
 Gipsfaserplatte 18mm, vertikale Fräsung für das RENO12 system

Article number	Multipack	Type
UFH-P18-GP18V	1 pc.	1000 x 600 x 18mm



# Henco Underfloor Heating

Underfloor Heating Systems

## Type: UFH-P18-GP10



Gypsum fibreboard 10mm, flat for RENO12 system  
Gipsvezelplaat 10mm, Vlak Voor Reno12 Systeem  
Plaques en fibro-plâtre 10mm, système RENO12  
Gipsfaserplatte 10mm, flach für das RENO12 system

Article number	Multipack	Type
UFH-P18-GP10	1 pc.	1500 x 1000 x 10mm

## Type: UFH-P18-WN



Mesh for RENO12 system  
Wapeningsnet voor RENO12 systeem  
Treillis d'armature pour le système reno12  
Betonstahlmatte für das RENO12 system

Article number	Coil	Type
UFH-P18-WN*	1 m	1 x 50m

*\*TILL EXHAUSTION OF STOCK*

## Type: UFH-ISODRY-25



Insulation system board for dry system  
Isolatieplaat voor droog systeem  
Panneau d'isolation pour système sec  
Systemplatte für Trockenbau

Article number	Multipack	Type
UFH-ISODRY-25	10 m2	1000x500x25mm

## Type: UFH-DRY-GP100/2



Heat diffusion profile for dry system  
Stralingsprofiel voor droog systeem  
Profil de diffusion pour système sec  
Wärmeleitlamelle für Trockenbau

Article number	Box	Type
UFH-DRY-GP100/2	50 pc.	997x120x0,4mm - Ø16

## Type: UFH-DRY-VD100



Heat diffusion board for dry system  
Stralingsverdeelpaat voor droog systeem  
Panneau de diffusion pour système sec  
Verteillerbleche für Trockenbau

Article number	Multipack	Type
UFH-DRY-VD100*	1 pc.	1000x1000mm

*\*TILL EXHAUSTION OF STOCK*

## Type: UFH-UP-M



Clip rail with adhesive strip, centres 50 mm  
U-profiel met kleefband, verlegafstand 50 mm  
Profil-U avec bande adhésif, distance de pose 50 mm  
Kunststoffclip-Schiene klebfertig für Rohr, Verlegung 50 mm

Article number	Box	Type
UFH-UP-14M1	100 pc.	Ø14 - AS 25 mm- 1000 mm
UFH-UP-16M1	100 pc.	Ø16 - AS 50 mm- 1000 mm



## Type: UFH-UP



Clip rail with adhesive strip, centres 50 mm  
 U-profiel met kleefband, verlegafstand 50 mm  
 Profil-U avec bande adhésif, distance de pose 50 mm  
 Kunststoffclip-Schiene klebfertig für Rohr, Verlegung 50 mm

Article number	Box / Pallet	Type
UFH-UP-12	40 m / 1200 m	Ø12 - AS 25 mm- 2000 mm
UFH-UP-16	100 m / 3000 m	Ø16 - AS 50 mm- 2500 mm

## Type: UFH-UP-CUP



Staple for clip rail  
 Clip voor U-profielen  
 Agrafe pour profil-U  
 Nadel für Schienen

Article number	Box	Type
UFH-UP-CUP50	500 pc.	50 mm

## Type: UFH-FOIL



PE film, transparant, with blue grid marking 50 x 50 mm  
 PE-folie, transparant, blauwe rastermarkering 50 x 50 mm  
 Film en PE, transparent avec marquage 50 x 50 mm en bleu  
 Polyethylen-Schutzfolie,transparent,Markierung Blau 50x50mm

Article number	Roll	Type
UFH-FOIL50	51 m <sup>2</sup>	50X50mm 50m <sup>2</sup>
UFH-FOIL90	90 m <sup>2</sup>	50X50m 90m <sup>2</sup>

## Type: UFH-FOIL-N



Pe film,neutral  
 Pe-Folie,Neutraal  
 Film en pe ,neutre  
 Polyethylen-schutzfolie,neutral

Article number	Roll	Type
UFH-FOIL-N	100 m <sup>2</sup>	50 m x 2 m - 0,2 mm

## Type: UFH-FOIL-ALU



PE film, reflecting ALU  
 PE-folie, met PE-flap en ALU reflectie  
 Film en PE avec réflexion ALU  
 Polyethylen-Schutzfolie, Refltion ALU

Article number	Roll	Type
UFH-FOIL-ALU	50 m <sup>2</sup>	50 m x 1 m - 3,0 mm

## Type: UFH-FOIL-CLIP25



Clip for Film  
 Dampfolienagel  
 Agrafe pour film PE  
 Foliendübel

Article number	Bag	Type
UFH-FOIL-CLIP25	100 pc.	25mm

1

2

3

4

5

6

7

8

9

10

11

12



# Henco Underfloor Heating

Underfloor Heating Systems

## 1 Type: UFH-PLUG80



Plug, shaft length 80 mm, Ø8 mm  
Montageplug, schachtlengte 80 mm, Ø8 mm  
Cheville de montage, longueur 80 mm, Ø8 mm  
Niederhaltedübel, Bohrer Ø 8 mm, Schaftlänge 80 mm

Article number	Bag / Box	Type
UFH-PLUG80	100 pc. / 1000 pc.	80 mm, Ø8 mm

## 5 Type: UFH-ISOBOARD-S



PE edge isolation with lapping strip and adhesive strip  
Randisolatie uit PE-schuim met flap en kleefstroken  
Isolation périphérique en PE avec rabat et bande adhésif  
Randdämmstreifen aus PE mit Abrisskante und Klebestreifen

Article number	Roll	Type
UFH-ISOBOARD-S	25 m	150 x 8 mm

## 10 Type: UFH-ISOBOARD-GVNL



PE edge isolation with lapping strip and adhesive strip for liquid floors  
Randisolatie voor gietvloeren uit PE-schuim met flap en kleefstroken  
Isolation périphérique en PE avec rabat et bande adhésif pour sols coulés  
Randdämmstreifen aus PE mit Abrisskante und Klebestreifen für Gussböden

Article number	Roll	Type
UFH-ISOBOARD-GVNL	50 m	100 mm x 8 mm

## Type: UFH-ISOBOARD-GV



PE edge isolation with lapping strip and adhesive strip for anhydrite screed  
Randiso. voor anhydriet chape uit PE-schuim met flap en kleefstroken  
Isolation périphérique en PE avec rabat et bande adhésif, pour chape anhydrite  
Randdämmstreifen aus PE mit Abrisskante und Klebestreifen, für Anhydritestrich

Article number	Roll	Type
UFH-ISOBOARD-GV	25 m	150 mm x 8 mm

## Type: UFH-DP200



PE expansion joint with self-adhesive rail  
Uitzettingsvoeg uit PE-schuim met zelfklevende rail  
Joint de dilatation en PE avec bande adhésive  
Dehnungsfuge aus PE mit Klebestreifen

Article number	Pack / Box	Type
UFH-DP200	10 pc. / 50 pc.	2000 mm x 100 mm x 8 mm



## Type: UFH-DH40



Protection sleeve for expansion joint  
 Voegdoorganghuls  
 Gaine de protection pour joint de dilatation  
 Schutzrohre für Dehnungsfugen

Article number	Box	Type
UFH-DH40	100 pc.	400 mm

## Type: UFH-BEND



Bend guide for pipe  
 Geleidingsbocht voor buis  
 Courbe pour tube  
 Rohrführungsbogen

Article number	Bag / Box	Type
UFH-BEND1218	50 pc. / 400 pc.	Ø 12 - 18 mm
UFH-BEND20	50 pc. / 100 pc.	Ø 20 mm

## Type: UFH-ADN10



Additive for screed (min. pipe covering 45 mm)  
 Toevoegmiddel voor zandcementdekvloer (min. buisoverdekking 45 mm)  
 Additif pour chape de ciment (min. épaisseur de chape au-dessus du tube 45 mm)  
 Estrichzusatz (min. Rohrüberdeckung 45 mm)

Article number	Drum	Type
UFH-ADN10	10 L	

- 1
- 2
- 3
- 4
- 5
- 6
- 7
- 8
- 9
- 10
- 11
- 12



# Henco Underfloor Heating

District Heating Manifolds

## Type: UFH-CDP



Composite manifold, adjustable with flow meter and A-pump  
 Composiet verdeler, regelbaar met debietmeting en A-pomp  
 Collecteur composite, réglable avec débitmètre et pompe label A  
 Verteiler Composite, regelbar mit Durchflüssenmengenzähler und A-Pumpe

Article number	Box	Type
UFH-0405CDP01	1 pc.	1/2" - 1 x 3/4"
UFH-0405CDP02	1 pc.	1/2" - 2 x 3/4"
UFH-0405CDP03	1 pc.	1/2" - 3 x 3/4"
UFH-0405CDP04	1 pc.	1/2" - 4 x 3/4"
UFH-0405CDP05	1 pc.	1/2" - 5 x 3/4"
UFH-0405CDP06	1 pc.	1/2" - 6 x 3/4"
UFH-0505CDP07	1 pc.	3/4" - 7 x 3/4"
UFH-0505CDP08	1 pc.	3/4" - 8 x 3/4"
UFH-0505CDP09	1 pc.	3/4" - 9 x 3/4"
UFH-0505CDP10	1 pc.	3/4" - 10 x 3/4"
UFH-0505CDP11	1 pc.	3/4" - 11 x 3/4"
UFH-0505CDP12	1 pc.	3/4" - 12 x 3/4"
UFH-0505CDP13	1 pc.	3/4" - 13 x 3/4"
UFH-0505CDP14	1 pc.	3/4" - 14 x 3/4"
UFH-0505CDP15	1 pc.	3/4" - 15 x 3/4"
UFH-0505CDP16	1 pc.	3/4" - 16 x 3/4"

## Type: UFH-CD



Composite manifold, adjustable with flow meter  
 Composiet verdeler, regelbaar met debietmeting  
 Collecteur composite, réglable avec débitmètre  
 Verteiler Composite, regelbar mit Durchflüssenmengenzähler

Article number	Box	Type
UFH-0605CD01	1 pc.	1" - 1 x 3/4"
UFH-0605CD02	1 pc.	1" - 2 x 3/4"
UFH-0605CD03	1 pc.	1" - 3 x 3/4"
UFH-0605CD04	1 pc.	1" - 4 x 3/4"
UFH-0605CD05	1 pc.	1" - 5 x 3/4"
UFH-0605CD06	1 pc.	1" - 6 x 3/4"
UFH-0605CD07	1 pc.	1" - 7 x 3/4"
UFH-0605CD08	1 pc.	1" - 8 x 3/4"
UFH-0605CD09	1 pc.	1" - 9 x 3/4"
UFH-0605CD10	1 pc.	1" - 10 x 3/4"
UFH-0605CD11	1 pc.	1" - 11 x 3/4"
UFH-0605CD12	1 pc.	1" - 12 x 3/4"
UFH-0605CD13	1 pc.	1" - 13 x 3/4"
UFH-0605CD14	1 pc.	1" - 14 x 3/4"
UFH-0605CD15	1 pc.	1" - 15 x 3/4"
UFH-0605CD16	1 pc.	1" - 16 x 3/4"
UFH-0605CD17	1 pc.	1" - 17 x 3/4"
UFH-0605CD18	1 pc.	1" - 18 x 3/4"
UFH-0605CD19	1 pc.	1" - 19 x 3/4"
UFH-0605CD20	1 pc.	1" - 20 x 3/4"

## Type: UFH-CP



A-pump unit for composite collector  
 Pompunit composiet verdeler, met A-pomp  
 Kit pompe-A pour collecteur composite  
 A-Pump Unit für Composite Verteiler

Article number	Box	Type
UFH-CP	1 pc.	1"





## Type: UFH-SLT



Including cord, plug and maximum thermostat.

Steel collector with A-pump

Stalen verdeler met A-pomp en LTV inregelventiel

Stalen verdeler met A-pomp en LTV inregelventiel

Stalen verdeler met A-pomp en LTV inregelventiel

Article number	Box	Type
UFH-0405SLT01	1 pc.	1/2" - 1 x 3/4"
UFH-0405SLT02	1 pc.	1/2" - 2 x 3/4"
UFH-0405SLT03	1 pc.	1/2" - 3 x 3/4"
UFH-0405SLT04	1 pc.	1/2" - 4 x 3/4"
UFH-0405SLT05	1 pc.	1/2" - 5 x 3/4"
UFH-0405SLT06	1 pc.	1/2" - 6 x 3/4"
UFH-0505SLT07	1 pc.	3/4" - 7 x 3/4"
UFH-0505SLT08	1 pc.	3/4" - 8 x 3/4"
UFH-0505SLT09	1 pc.	3/4" - 9 x 3/4"
UFH-0505SLT10	1 pc.	3/4" - 10 x 3/4"
UFH-0505SLT11	1 pc.	3/4" - 11 x 3/4"
UFH-0505SLT12	1 pc.	3/4" - 12 x 3/4"
UFH-0505SLT14	1 pc.	3/4" - 14 x 3/4"
UFH-0505SLT15	1 pc.	3/4" - 15 x 3/4"
UFH-0505SLT16	1 pc.	3/4" - 16 x 3/4"

## Type: UFH-SSTE



Including cord, plug and maximum thermostat.

Steel collector with pump, district heating Essent

Stalen verdeler met pomp, stadsverwarming Essent

Collecteur en acier avec pompe, chauffage urbain Essent

Verteiler Stahl mit Pump, Fernheizung Essent

Article number	Box	Type
UFH-0405SSTE02-PN6	1 pc.	1/2" - 2 x 3/4"
UFH-0405SSTE03-PN6	1 pc.	1/2" - 3 x 3/4"
UFH-0405SSTE04-PN6	1 pc.	1/2" - 4 x 3/4"
UFH-0405SSTE06-PN6	1 pc.	1/2" - 6 x 3/4"
UFH-0505SSTE07-PN6	1 pc.	3/4" - 7 x 3/4"
UFH-0505SSTE08-PN6	1 pc.	3/4" - 8 x 3/4"
UFH-0505SSTE09-PN6	1 pc.	3/4" - 9 x 3/4"
UFH-0505SSTE10-PN6	1 pc.	3/4" - 10 x 3/4"
UFH-0505SSTE11-PN6	1 pc.	3/4" - 11 x 3/4"
UFH-0505SSTE12-PN6	1 pc.	3/4" - 12 x 3/4"



# Henco Underfloor Heating

Underfloor Heating Synthetic Manifolds

## Type: UFH-MDK



Composite manifold, adjustable with flow meter, washer and air vent

Composiet verdeler, regelbaar met debietmeting, therm, vul-aftapkraan, ontluchter

Collecteur composite, réglable avec débitmètre, thermomètre, vanne d'apport et purgeur d'air

Verteiler Composite, regelbar mit Durchflüssenmengenzahl, therm, Entleerung-Entluft.

Article number	Box	Type
UFH-0605MDK02-03L	1 pc.	1" - 2 x 3/4"
UFH-0605MDK03-03L	1 pc.	1" - 3 x 3/4"
UFH-0605MDK04-03L	1 pc.	1" - 4 x 3/4"
UFH-0605MDK05-03L	1 pc.	1" - 5 x 3/4"
UFH-0605MDK06-03L	1 pc.	1" - 6 x 3/4"
UFH-0605MDK07-03L	1 pc.	1" - 7 x 3/4"
UFH-0605MDK08-03L	1 pc.	1" - 8 x 3/4"
UFH-0605MDK09-03L	1 pc.	1" - 9 x 3/4"
UFH-0605MDK10-03L	1 pc.	1" - 10 x 3/4"
UFH-0605MDK11-03L	1 pc.	1" - 11 x 3/4"
UFH-0605MDK12-03L	1 pc.	1" - 12 x 3/4"

NEW\*  
PRODUCT

## Type: UFH-MDK-PRM



Pre-mounted composite manifold, adjustable with flow meter, washer and air vent

Voorgemonteerde composiet verdeler, regelbaar met debietmeting, therm, vul-aftapkraan, ontluchter

Collecteur composite pré-assemblé, réglable avec débitmètre, thermomètre, vanne d'apport et purgeur d'air

Vormontierter verteiler Composite, regelbar mit Durchflüssenmengenzahl, therm, Entleerung-Entluft.

Article number	Box	Type
UFH-0605MDK02-03LPRM	1 pc.	1" - 2 x 3/4"
UFH-0605MDK03-03LPRM	1 pc.	1" - 3 x 3/4"
UFH-0605MDK04-03LPRM	1 pc.	1" - 4 x 3/4"
UFH-0605MDK05-03LPRM	1 pc.	1" - 5 x 3/4"
UFH-0605MDK06-03LPRM	1 pc.	1" - 6 x 3/4"
UFH-0605MDK07-03LPRM	1 pc.	1" - 7 x 3/4"
UFH-0605MDK08-03LPRM	1 pc.	1" - 8 x 3/4"
UFH-0605MDK09-03LPRM	1 pc.	1" - 9 x 3/4"
UFH-0605MDK10-03LPRM	1 pc.	1" - 10 x 3/4"
UFH-0605MDK11-03LPRM	1 pc.	1" - 11 x 3/4"
UFH-0605MDK12-03LPRM	1 pc.	1" - 12 x 3/4"



## Type: UFH-MDSS



Stainless steel manifold  
Roestvrij stalen verdeler  
Collecteur en acier inoxydable  
Edelstahlverteiler

Article number	Box	Type
UFH-0605MDSS02	1 pc.	1" -2X3/4
UFH-0605MDSS03	1 pc.	1" -3X3/4
UFH-0605MDSS04	1 pc.	1" -4X3/4
UFH-0605MDSS05	1 pc.	1" -5X3/4
UFH-0605MDSS06	1 pc.	1" -6X3/4
UFH-0605MDSS07	1 pc.	1" -7X3/4
UFH-0605MDSS08	1 pc.	1" -8X3/4
UFH-0605MDSS09	1 pc.	1" -9X3/4
UFH-0605MDSS10	1 pc.	1" -10X3/4
UFH-0605MDSS11	1 pc.	1" -11X3/4
UFH-0605MDSS12	1 pc.	1" -12X3/4
UFH-0605MDSS13	1 pc.	1" -13X3/4
UFH-0605MDSS14	1 pc.	1" -14X3/4
UFH-0605MDSS15	1 pc.	1" -15X3/4

- 1
- 2
- 3
- 4
- 5
- 6
- 7
- 8
- 9
- 10
- 11
- 12



# Henco Underfloor Heating

Underfloor Heating Manifolds

## Type: UFH-MDK-CON



Composite connector for MDK Manifold  
 Composiet verbinder voor MDK Verdeler  
 Connecteur en composite pour collecteur MDK  
 Composite connector for MDK Manifold

Article number	Bag / Box	Type
UFH-MDK-CON	1 pc. / 50 pc.	

## Type: UFH-MDK-AO



Automatic air vent in composite for MDK manifold  
 Automatische ontluchter composiet voor MDK verdeler  
 Purgeur automatique en composite pour collecteur MDK  
 Automatische entlüftung in composiet für MDK verteiler

Article number	Bag	Type
UFH-MDK-AO	1 pc.	3/8"

## Type: UFH-CMDK



Flow meter for MDK manifold  
 Debietmeter voor MDK verdeler  
 Débitmètre pour collecteur MDK  
 Durchflussmengenanzeiger für MDK Verteiler

Article number	Bag	Type
UFH-CMDK03	1 pc.	0 - 5 l/min
UFH-CMDK10	1 pc.	0 - 2,5 l/min

## Type: UFH-06-MD



Manifold brass, adjustable, with flow meters  
 Verdeler messing, regelbaar, met debietmeting  
 Collecteur en laiton, réglable, avec débitmètres  
 Verteiler aus Messing, regelbar, mit Durchflüssenmengenzähler

Article number	Box	Type
UFH-060502-MD	1 pc.	1" - 2X3/4
UFH-060503-MD	1 pc.	1-3X3/4
UFH-060504-MD	1 pc.	1-4X3/4
UFH-060505-MD	1 pc.	1-5X3/4
UFH-060506-MD	1 pc.	1-6X3/4
UFH-060507-MD	1 pc.	1-7X3/4
UFH-060508-MD	1 pc.	1-8X3/4
UFH-060509-MD	1 pc.	1-9X3/4
UFH-060510-MD	1 pc.	1-10X3/4
UFH-060511-MD	1 pc.	1-11X3/4
UFH-060512-MD	1 pc.	1-12X3/4

## Type: UFH-M-D



Flow meter for brass manifold  
 Debietmeter voor messing verdeler  
 Débitmètre pour collecteur en laiton  
 Durchflussmengenanzeiger für Verteiler aus Messing

Article number	Box	Type
UFH-M-D	1 pc.	0-6 l/min



## Type: UFH-CMDSS03



Flow meter for MDSS manifold  
Debietmeter voor MDSS verdeler  
Débitmètre pour collecteur MDSS  
Durchflussmengenanzeiger für MDSS Verteiler

Article number	Bag	Type
UFH-CMDSS03	1 pc.	0 - 5 l/min

## Type: UFH-PGKTA



Pump unit A label pump with consistent temperature control  
Pompgroep A-label met regeling voor constante temperatuur  
Kit pompe label A avec régulation de température constante  
Konstanttemperaturregelung mit A-Pumpe

Article number	Box	Type
UFH-PGKTA	1 pc.	1°F / 27°C - 42°C

## Type: UFH-PGKTA-TH



Thermostatic sensor  
Thermostaat kop  
Tête thermostatique  
Thermostatkopf

Article number	Box	Type
UFH-PGKTA-TH	1 pc.	

## Type: UFH-GKT



Unit with consistent temperature control without pump  
Groep met regeling voor constante temperatuur zonder pomp  
Kit avec régulation de température constante sans pompe  
Konstanttemperaturregelung ohne Pump

Article number	Box	Type
UFH-GKT	1 pc.	1°F / 27°C - 42°C

## Type: UFH-BT



1°F ball valve with 1°F swivel nut, washer and thermometer  
Kogelkraan 1°F met wartelmoer 1°F, dichting en thermometer  
Vanne à sphère 1°F avec écrou 1°F, joint et thermomètre  
Kugelhahnset 1°IG mit Mutter 1°IG ,Dichtung und Thermometer

Article number	Bag / Box	Type
UFH-BTM0606-M	1 pc. / 20 pc.	1°F x 1°F / 0 - 60 °

1

2

3

4

5

6

7

8

9

10

11

12



# Henco Underfloor Heating

Underfloor Heating Manifolds

## Type: UFH-B



1" F ball valve with 1" F swivel nut and washer  
Kogelkraan 1" F met wartelmoer 1" F en dichting  
Vanne à sphère 1" F avec écrou 1" F et joint plat  
Kugelhahnset 1" IG mit Mutter 1" IG und Dichtung

Article number	Bag / Box	Type
UFH-B0606-M	1 pc. / 25 pc.	1" F x 1" F

## Type: UFH-ESK



1" F end cap with nut, washer, ball valve and air vent 3/8"  
Eindstuk 1" F met moer, dichting, kogelkraan en ontluichtingskraan 3/8"  
Bouchon terminal 1" F avec écrou, vanne à sphère, joint et purgeur 3/8"  
Verteilerendstückset 1" IG mit Mutter und Dichtung, Enlüftung 3/8", Kugelhahnset

Article number	Bag / Box	Type
UFH-ESK060303-M	1 pc. / 25 pc.	1" F x 1/2" x 3/8"

## Type: UFH-ESK-VN



1" F end cap with nut, washer, ball valve and air vent 3/8", nickel-plated  
Eindstuk 1" F met moer, dichting, kogelkraan en ontluichtingskraan 3/8", vernikkeld  
Bouchon terminal 1" F avec écrou, joint et purgeur 3/8", nickelé  
Verteilerendstückset 1" IG mit Mutter und Dichtung, Enlüftung 3/8", Kugelhahnset, vernikkelt Article num

Article number	Bag / Box	Type
UFH-ESK060303-VN*	2 pc. / 20 pc.	1" F x 1/2" x 3/8"

*\*TILL EXHAUSTION OF STOCK*

## Type: UFH-AO-MZ



Automatic air vent, without check valve  
Automatische ontluichter, zonder waterslot  
Purgeur automatique, sans serrure d'eau  
Schnellentlüfter mit vertikaler Entlüftung, ohne Wasserabspernung

Article number	Bag / Box	Type
UFH-AO03-MZ	1 pc. / 50 pc.	3/8"

## Type: UFH-TM-M



Thermometer for return with EK connections  
Thermometer voor terugvoer met euroconus aansluitingen  
Retour thermomètre avec raccordement eurocone  
Thermometer zum Anschluss Rucklauf mit Eurokonus-Anschlüssen

Article number	Bag / Box	Type
UFH-TM050-M	1 pc. / 72 pc.	3/4" - 3/4" EK / 0 - 50°C

## Type: UFH-BS-M



End cap with washer  
Blindstop  
Bouchon  
Kappe mit Dichtung

Article number	Bag / Box	Type
UFH-BS05-M	1 pc. / 50 pc.	3/4"



## Type: UFH-C260003001



Thermostatic temperature limiter 3/4"xEK  
 Thermostatische temperatuurbegrenzer 3/4"xEK  
 Limiteur de température thermostatique 3/4"xEK  
 Thermostatischer Temperaturbegrenzer 3/4"xEK

Article number	Bag / Box	Type
UFH-C260003001	1 pc. / 50 pc.	3/4"

## Type: UFH-B-VN



1" F ball valve with 1" F swivel nut and washer , nickel-plated  
 Kogelkraan 1" F met wartelmoer 1" F en dichting, vernikkeld  
 Vanne à sphère 1" F avec écrou 1" F et joint, nickelé  
 Kugelhahnset 1" IG mit Mutter 1" IG und Dichtung, vernickelt

Article number	Bag / Box	Type
UFH-B0606-VN	1 set (2 pc.) / 10 sets	1" F x 1" F / 0 - 60°

*\*TILL EXHAUSTION OF STOCK*

## Type: UFH-BMH-VN



Ball valve 90° with gasket, nickel plated (MDK and MDSS manifold), no thermometer  
 Kogelkraan 90° met dichting, vernikkeld (MDK en MDSS verdeler), geen thermometer  
 Vanne à sphère 90° et joint, nickelé (collecteur MDK et MDSS), sans thermomètre  
 Kugelhahnset 90°, vernickelt (Verteiler MDK und MDSS), ohne thermomètre

Article number	Box / Big Box	Type
UFH-BMH0606-VN	1 set (2 pc.) / 10 sets	1"x1"

## Type: UFH-BMHT-VN



Ball valve 90° with gasket, nickel plated (MDK and MDSS manifold), thermometer  
 Kogelkraan 90° met dichting, vernikkeld (MDK en MDSS verdeler), met thermometer  
 Vanne à sphère 90° et joint, nickelé (collecteur MDK et MDSS), avec thermomètre  
 Kugelhahnset 90°, vernickelt (für Verteiler MDK und MDSS), mit thermomètre

Article number	Box / Big Box	Type
UFH-BMH0606T-VN	1 set (2 pc.) / 12 sets	1"x1"

## Type: UFH-BM-VN



Ball valve with gasket, nickel plated (for MDK and MDSS manifold)  
 Kogelkraan met dichting, vernikkeld (voor MDK en MDSS verdeler)  
 Vanne à sphère et joint, nickelé (pour collecteur MDK et MDSS)  
 Kugelhahnset, vernickelt (für Verteiler MDK und MDSS)

Article number	Box / Big Box	Type
UFH-B0605-VN*	1 set (2 pc.) / 15 sets	3/4" x 1"
UFH-BM0606-VN	1 set (2 pc.) / 10 sets	1"x1"

*\*TILL EXHAUSTION OF STOCK*



# Henco Underfloor Heating

Underfloor Heating Manifolds

## Type: UFH-C192071



Safety thermostat incl. wire/plug  
Maximaalthermostaat, incl. snoer/stekker  
Thermostat de sécurité, incl. fil/prise  
Maximal Thermostat incl. Snur/Stecker

Article number	Bag	Type
UFH-C192071	1 pc.	

## Type: UFH-C191800



Thermometer with immersion sleeve 0/60°C  
Thermometer with immersion sleeve 0/60°C  
Thermomètre temp. 0/60°C avec bulbe  
Thermometer mit Tauchhülse 0/60°C

Article number	Bag	Type
UFH-C191800	1 pc.	

## Type: UFH-C191974



Circulator Wilo Yonos Para RS 15/6-RKA KU 130mm (excl. wire/plug)  
Circulator Wilo Yonos Para RS 15/6-RKA KU 130mm (excl. snoer/stekker)  
Circulateur Wilo Yonos Para RS 15/6-RKA KU 130mm (excl. fil/prise)  
Cirkulator Wilo Yonos Para RS 15/6-RKA KU 130mm (excl. Snur/Stecker)

Article number	Bag	Type
UFH-C191974	1 pc.	1"

## Type: UFH-C191976



Circulator Wilo Yonos Para RS 25/6-RKA KU 130mm (excl. wire/plug)  
Circulator Wilo Yonos Para RS 25/6-RKA KU 130mm (excl. snoer/stekker)  
Circulateur Wilo Yonos Para RS 25/6-RKA KU 130mm (excl. fil/prise)  
Cirkulator Wilo Yonos Para RS 25/6-RKA KU 130mm (excl. Snur/Stecker)

Article number	Bag	Type
UFH-C191976	1 pc.	1 1/2"





**Wired control unit**  
**Bekabelde zoneregeling**  
**Régulateurs de zone cablés**  
**Regelverteiler verdrahtet**

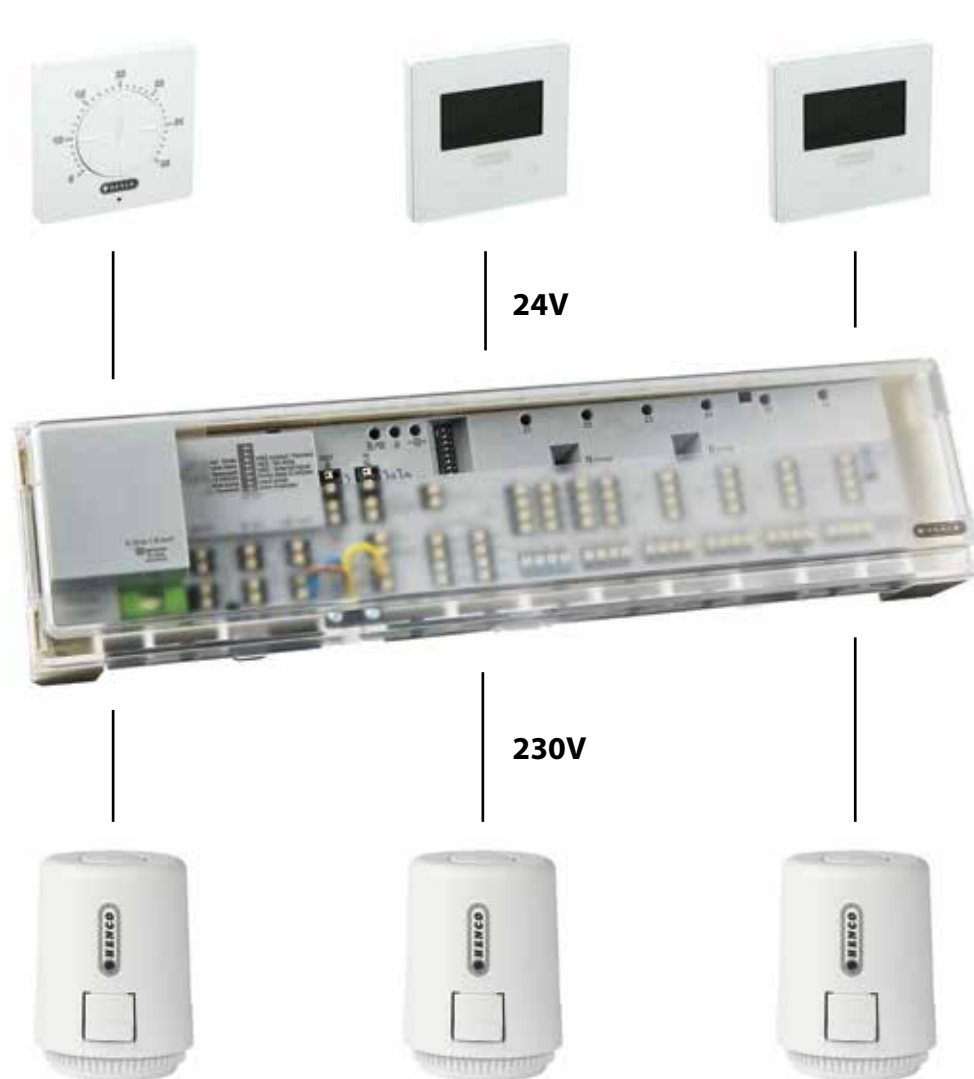

1

2

3

4

5

6

7

8

9

10

11

12



# Henco Underfloor Heating

HencoLogic Wired

**NEW\***  
PRODUCT

## Type: CU-6ZONEB-H



Base module 6 zones heating, wired  
Basisstation 6 zones verwarmen, bekabeld  
Base module 6 zones chauffer, câble  
Regelkleimleiste 6-zonen Heizen, Verdrahtet

Article number	Box / Big Box	Type
CU-6ZONEB-H	1 pc. / 6 pc.	

## Type: CU-6ZONEB-HC

**NEW\***  
PRODUCT



Base module 6 zones heating/cooling, wired  
Basisstation 6 zones verwarmen/koelen, bekabeld  
Base module 6 zones chauffer/refroidir, câble  
Regelkleimleiste 6-zonen Heizen/Kuhlen, Verdrahtet

Article number	Box / Big Box	Type
CU-6ZONEB-HC	1 pc. / 6 pc.	

## Type: CU-6ZONE-CON

**NEW\***  
PRODUCT



Extension module 6 zones, wired  
Uitbreidingsmodule 6 zone, bekabeld  
Module d'extension 6 zones, câble  
Erweiterungsmodul 6-zonen Heizen/Kuhlen, Verdrahtet

Article number	Box / Big Box	Type
CU-6ZONE-CON	1 pc. / 6 pc.	

## Type: CU-ATHERMB-H

**NEW\***  
PRODUCT



Analog thermostat heating, wired  
Analoge thermostaat verwarmen, bekabeld  
Thermostat analogue chauffer, câble  
Analog Raumthermostat Heizen, Verdrahtet

Article number	Box / Big Box	Type
CU-ATHERMB-H	1 pc. / 84 pc.	

## Type: CU-ATHERMB-HC

**NEW\***  
PRODUCT



Analog thermostat heating/cooling, wired  
Analoge thermostaat verwarmen/koelen, bekabeld  
Thermostat analogue chauffer/refroidir, câble  
Analog Raumthermostat Heizen/Kuhlen, Verdrahtet

Article number	Box / Big Box	Type
CU-ATHERMB-HC	1 pc. / 84 pc.	



## Type: CU-DTHERMB-HC

**NEW**  
PRODUCT



Digital thermostat heating/cooling, wired  
Digitale thermostaat verwarmen/koelen, bekabeld  
Thermostat digitale chauffer/refroidir, câble  
LCD Raumthermostat Heizen/Kuhlen, Verdrahtet

Article number	Box / Big Box	Type
CU-DTHERMB-HC	1 pc. / 84 pc.	

## Type: CU-ACT-B230V

**NEW**  
PRODUCT



Actuator with cable 1m  
Actuator met vaste kabel 1m  
Electrovanne avec cable 1m  
Stellantrieb Kabel 1m

Article number	Box / Big Box	Type
CU-ACT-B230V	1 pc. / 100 pc.	230V

- 1
- 2
- 3
- 4
- 5
- 6
- 7
- 8
- 9
- 10
- 11
- 12



# Henco Underfloor Heating

HencoLogic Wireless

- 1
- 2
- 3
- 4
- 5
- 6
- 7
- 8**
- 9
- 10
- 11
- 12

**Wireless control unit (Heating/cooling)**  
**Draadloze zoneregeling (Verwarmen/koelen)**  
**Régulateurs de zone sans fil (Chauffage/refroidissement)**  
**Regelverteiler funk (Heizen/kühlen)**



230V





## Type: CU-6ZONERF-HC

**NEW\***  
PRODUCT



Base module 6 zones heating/cooling, wireless  
Basisstation 6 zones verwarmen/koelen, draadloos  
Base module 6 zones chauffer/refroidir, sans fil  
Regelklemeleiste 6-zonen Heizen, Funk

Article number	Box / Big Box	Type
CU-6ZONERF-HC	1 pc. / 6 pc.	

## Type: CU-10ZONERF-HC

**NEW\***  
PRODUCT



Base module 10 zones heating/cooling, wireless  
Basisstation 10 zones verwarmen/koelen, draadloos  
Base module 10 zones chauffer/refroidir, sans fil  
Regelklemeleiste 10-zonen Heizen/Kuhlen, Funk

Article number	Box / Big Box	Type
CU-10ZONERF-HC	1 pc. / 6 pc.	

## Type: CU-ZONERF-HC

**NEW\***  
PRODUCT



Extension module heating/cooling, wireless  
Uitbreidingsmodule verwarmen/koelen, draadloos  
Module d'extension chauffer/refroidir, sans fil  
Erweiterungsmodul Heizen/Kuhlen, Funk

Article number	Box / Big Box	Type
CU-ZONERF-HC	1 pc. / 6 pc.	

## Type: CU-ATHERMRF-HC

**NEW\***  
PRODUCT



Analog thermostat heating/cooling, wireless  
Analoge thermostaat verwarmen/koelen, draadloos  
Thermostat analogue chauffer/refroidir, sans fil  
Analog Raumthermostat Heizen/Kuhlen, Funk

Article number	Box / Big Box	Type
CU-ATHERMRF-HC	1 pc. / 36 pc.	

## Type: CU-DTHERMRF-HC

**NEW\***  
PRODUCT



Digital thermostat heating/cooling, wireless  
Digitale thermostaat verwarmen/koelen, draadloos  
Thermostat digitale chauffer/refroidir, sans fil  
LCD Raumthermostat Heizen/Kuhlen, Funk

Article number	Box / Big Box	Type
CU-DTHERMRF-HC	1 pc. / 36 pc.	

- 1
- 2
- 3
- 4
- 5
- 6
- 7
- 8
- 9
- 10
- 11
- 12



# Henco Underfloor Heating

HencoLogic Wireless

## 1 Type: CU-WIFI

NEW\*  
PRODUCT



RF Wifi central unit  
RF Wifi centrale unit  
RF Wifi central unit  
RF Wifi central unit

Article number	Box / Big Box	Type
CU-WIFIRF	1 pc. / 17 pc.	

## 6 Type: CU-WIFIRFCABLE

NEW\*  
PRODUCT



Cable (USB B) RF WIFI central unit  
Kabel (USB B) RF WIFI-centrale  
Câble (USB B) RF WIFI central unit  
Kabel (USB B) RF WIFI zentraleinheit

Article number	Box / Big Box	Type
CU-WIFIRFCABLE	1 pc. / 112 pc.	

## 12 Type: CU-ANTRF

NEW\*  
PRODUCT



Antenne

Article number	Box	Type
CU-ANTRF	35 pc.	

## Type: CU-REPRF

NEW\*  
PRODUCT



RF repeater

Article number	Box / Big Box	Type
CU-REPRF	1 pc. / 34 pc.	

## Type: CU-RADTHERMRF

NEW\*  
PRODUCT



RF thermostatic radiator head  
RF thermostatische radiator kop  
Tête de radiateur thermostatique RF  
RF Thermostatischer Heizkörperkopf

Article number	Box / Big Box	Type
CU-RADTHERMRF	1 pc. / 48 pc.	

## Type: CU-ACT-B230V

NEW\*  
PRODUCT



Actuator with cable 1m  
Actuator met vaste kabel 1m  
Electrovanne avec cable 1m  
Stellantrieb Kabel 1m

Article number	Box / Big Box	Type
CU-ACT-B230V	1 pc. / 100 pc.	230V

# Henco Underfloor Heating Cabinets



# Henco Underfloor Heating Cabinets

NEW\*  
PRODUCT

## Type: UFH-CAB-I



Recessed manifold cabinet, RAL 9016  
Verdelerkast voor inbouw, RAL 9016  
Boîte à encastrer pour collecteurs, RAL 9016  
Verteilerschrank Unterputz, RAL 9016

Article number	Box	Type
UFH-CAB-I400	1 pc.	400x700-800x112-152mm
UFH-CAB-I455*	1 pc.	480x575-665x110-175mm
UFH-CAB-I565*	1 pc.	610x575-665x110-175mm
UFH-CAB-I600	1 pc.	600x700-800x112-152mm
UFH-CAB-I715*	1 pc.	760x575-665x110-175mm
UFH-CAB-I800	1 pc.	800x700-800x112-152mm
UFH-CAB-I965*	1 pc.	1010x575x665x110-175mm
UFH-CAB-I1000	1 pc.	1000x700-800x112-152mm

\*RAL9003

## Type: UFH-CAB-O

NEW\*  
PRODUCT



Surface mount manifold cabinet, RAL 9016  
Verdelerkast voor opbouw, RAL 9016  
Boîte à poser pour collecteurs, RAL 9016  
Verteilerschrank Aufputz, RAL 9016

Article number	Box	Type
UFH-CAB-O385*	1 pc.	385x580x120mm
UFH-CAB-O400	1 pc.	400x720x112mm
UFH-CAB-O600	1 pc.	600x720x112mm
UFH-CAB-O615*	1 pc.	615x580x120mm
UFH-CAB-O800	1 pc.	800x720x112mm
UFH-CAB-O1000	1 pc.	1000x720x112mm
UFH-CAB-O1015*	1 pc.	1015x580x120mm

\*RAL9003

## Type: UFH-CAB-OZ

NEW\*  
PRODUCT



Surface mount manifold without back, RAL 9003  
Verdelerkast zonder rug voor opbouw, RAL 9003  
Boîte à poser pour collecteurs sans plaque arrière, RAL 9003  
Verteilerschrank Aufputz ohne Rückwand, RAL 9003

Article number	Box	Type
UFH-CAB-O385Z	1 pc.	385x580x120mm
UFH-CAB-O615Z	1 pc.	615x580x120mm
UFH-CAB-O1015Z	1 pc.	1015x580x120mm





	<i>Page</i>
<i><b>Bending Tools</b></i>	<i><b>138</b></i>
<i><b>Cutting Tools</b></i>	<i><b>139</b></i>
<i><b>Calibration Tools</b></i>	<i><b>141</b></i>
<i><b>Pressing Tools</b></i>	<i><b>143</b></i>
<i><b>Smart Tools</b></i>	
<i><b>Underfloor Heating Tools</b></i>	<i><b>156</b></i>



# Henco Tools

Bending Tools

## 1 Type: SAFECUT



Cutter to open the packing paper  
 Mes om verpakkingspapier te openen  
 Couteau pour ouvrir le papier d'emballage  
 Schneider zum Öffnen der Verpackung

Article number	Box / Big Box	Type
SAFECUT	1 pc. / 10 pc.	SAFECUT

## 6 Type: PS



Pipe straightener  
 Buizenrichter  
 Redresseur  
 Rohrbegradiger

Article number	Box / Big Box	Type
PS-16	1 pc. / 30 pc.	Ø16
PS-20	1 pc. / 15 pc.	Ø20

## 11 Characteristics PS

- ▶ Simplifies installation and reduces labour
- ▶ Easy to use
- ▶ Less material usage and waste
- ▶ Accelerated flow for better efficiencies and reduced running costs
- ▶ Professional looking finish

## Type: BI



Internal bending spring  
 Binnenbuigveer  
 Ressort à plier intérieur  
 Biegefeder innen

Article number	Bag / Box	Type
BI-1410	1 pc. / 100 pc.	14x2 L=50 cm
BI-1612	1 pc. / 100 pc.	16x2 L=50 cm
BI-1612L	1 pc. / 50 pc.	16x2 L=100 cm
BI-1814	1 pc. / 75 pc.	18x2 L=50 cm
BI-2016	1 pc. / 75 pc.	20x2 L=50 cm
BI-2016L	1 pc. / 25 pc.	20x2 L=100 cm
BI-2620	1 pc. / 25 pc.	26x3 L=100 cm

## Type: BA



External bending spring  
 Buitenbuigveer  
 Ressort à plier extérieur  
 Biegefeder aussen

Article number	Bag / Box	Type
BA-1288	1 pc. / 50 pc.	12x1,88 L=50 cm
BA-1410	1 pc. / 50 pc.	14x2 L=50 cm
BA-1612	1 pc. / 50 pc.	16x2 L=50 cm
BA-1814	1 pc. / 50 pc.	18x2 L=50 cm
BA-2016	1 pc. / 50 pc.	20x2 L=50 cm



## Type: BM



**Bending tool**  
**Buigijzer**  
**Cintreuse**  
**Biegewerkzeug**

Article number	Box / Big Box	Type
BM-16	1 pc. / 15 pc.	for Ø16
BM-18*	1 pc. / NaN	for Ø18
BM-20	1 pc. / 6 pc.	for Ø20
BM-26	1 pc. / 8 pc.	for Ø26

*\*TILL EXHAUSTION OF STOCK*

## Type: BM-F



**Fast bending tool**  
**Snelbuig tool**  
**Cintreuse rapide**  
**Schnell Biegewerkzeug**

Article number	Box / Big Box	Type
BM-16F	1 pc. / 50 pc.	for Ø16
BM-20F	1 pc. / 40 pc.	for Ø20

## Type: IMPRESS



**Guillotine cutter for multilayer and protection hose**  
**Guillotineschaar voor meerlagenbuis en mantel**  
**Pince guillotine pour tuyau multicouche et gaine**  
**Guillotinezange für Mehrschichtrohr und Mantel**

Article number	Box / Big Box	Type
IM1426PRESS	1 pc. / 36 pc.	14 till 26 mm

## Type: IMPRESS-N



**Guillotine cutter for multilayer**  
**Guillotineschaar voor meerlagenbuis**  
**Pince guillotine pour tuyau multicouche**  
**Guillotinezange für Mehrschichtrohr**

Article number	Box / Big Box	Type
IM1426PRESS-N	1 pc. / 36 pc.	14 till 26 mm

## Type: IMEMPRESS



**Replacement blade for IMPRESS**  
**Vervangmes voor IMPRESS**  
**Replacement blade for IMPRESS**  
**Ersatzmesser für IMPRESS**

Article number	Bag / Box	Type
IMEM1426-PRESS	1 pc. / 150 pc.	14mm - 26mm



# Henco Tools

Cutting Tools

## Type: RSEM-PERS



Replacement blade for art. RS1420PRESS and RS2640PRESS  
 Vervangmes voor art. RS1420PRESS en RS2640PRESS  
 Lame pour art. RS1420PRESS et RS2640PRESS  
 Ersatzmesser für Art. RS1420PRESS UND RS2640PRESS

Article number	Box	Type
RSEM1420-PERS	1 pc.	14 till 20 mm
RSEM2640-PERS	1 pc.	26 till 40 mm

## Type: IM



Wheel cutter  
 Buizensnijder  
 Coupe-tube  
 Rohrschneidezange

Article number	Box / Big Box	Type
IM63	1 pc. / 15 pc.	14 till 63 mm

## Type: IMEM



Replacement blade for IM  
 Vervangmes voor IM  
 Coûteau de rechange pour IM  
 Ersatzmesser für IM

Article number	Bag / Box	Type
IMEM63	1 pc. / 150 pc.	14 till 63 mm

## Type: RS



Wheel cutter  
 Buizensnijder  
 Coupe-tube  
 Rohrschneidezange

Article number	Box	Type
RS32*	1 pc.	14 till 32 mm

*\*TILL EXHAUSTION OF STOCK*

## Type: PH



Pipe holder for diameters 16-20-26-32  
 Griptang voor buis diameter 16-20-26-32  
 Pince de maintien diamètre 16-20-26-32  
 Rohrhalter für Diameter 16-20-26-32

Article number	Box / Big Box	Type
PH-1632	1 pc. / 70 pc.	16-20-26-32 mm

## Characteristics PH

- ▶ Always sufficient grip when calibrating short pipe ends
- ▶ Prevents the pipe from turning during calibration
- ▶ Inspired by the classic nutcracker model
- ▶ Henco blue anodised aluminium
- ▶ Lightweight tool
- ▶ Suitable for pipe diameters of 16 - 20 - 26 - 32





**Type: KS-MSET1**



Set with KS-K and KS-M for Ø16, 20 and 26  
Set met KS-K en KS-M voor Ø16, 20 en 26  
Set avec KS-K et KS-M pour Ø16, 20 et 26  
Set mit KS-K und KS-M für Ø16, 20 und 26

Article number	Box	Type
KS-MSET1	1 pc.	Ø16,Ø20,Ø26

**Type: KS-MSET4**



Set with KS-K and KS-M for Ø16, 20, 26 and 32  
Set with KS-K and KS-M for Ø16, 20, 26 and 32  
Set avec KS-K et KS-M pour Ø16, 20, 26 et 32  
Set mit KS-K und KS-M für Ø16, 20, 26 und 32

Article number	Box	Type
KS-MSET4	1 pc.	Ø16,Ø20,Ø26,Ø32

**Type: KS**



Kalispeed for electric drills (max. 500 rpm, clockwise only)  
Kalispeed voor accu-boormachine (max. 500 toeren, rechts draaien verplicht)  
Kalispeed pour perceuses à batterie (max. 500 tournages, obligation de tourner à droite)  
Kalispeed für Akku-Bohrmaschine (max. 500 Drehungen, rechts drehen verpflichtet)

Article number	Box	Type
KS50	1 pc.	for Ø50
KS63	1 pc.	for Ø63

**Type: KS-M**



Kalispeed, metal, for KS-K and electric drills (max. 500 rpm, clockwise only)  
Kalispeed, metaal, voor KS-K en accu-boormachine (max. 500 toeren, rechts draaien verplicht)  
Kalispeed, métal, pour KS-K et perceuses à batterie (max. 500 tours, obligation de tourner à droite)  
Kalispeed, Metall, für KS-K und Akku-Bohrmaschine (max. 500 Drehungen, rechts drehen verpflichtet)

Article number	Box	Type
KS12M	1 pc.	for Ø12
KS14M	1 pc.	for Ø14
KS16M	1 pc.	for Ø16
KS18M	1 pc.	for Ø18
KS20M	1 pc.	for Ø20
KS26M	1 pc.	for Ø26
KS32M	1 pc.	for Ø32
KS40M	1 pc.	for Ø40



# Henco Tools

Calibration Tools

1

## Type: KS-K

2



3

4

5

Clickhandle for KS (Kalispeed)  
Klikhandvat voor KS (Kalispeed)  
Manche clic pour KS (Kalispeed)  
Klickgriff für KS (Kalispeed)

Article number	Box	Type
KS-K	1 pc.	up to Ø40 mm

6

## Type: KS-P

7



8

9

10

11

12

Kalispeed for Ø16, 20 and 26  
Kalispeed voor Ø16, 20 en 26  
Kalispeed pour Ø16, 20 et 26  
Kalispeed für Ø16, 20 und 26

Article number	Box / Big Box	Type
KS-P162026	1 pc. / 288 pc.	for Ø16, 20 and 26

*Not for intensive use*



**Type: M-BA03**



Kit: accu-persmachine + accu + lader + koffer, lineaire aandrijving 32 tot 40 kN  
 Kit: accu-persmachine + accu + lader + koffer, lineaire aandrijving 32 tot 40 kN  
 Kit: machine à sertir + batterie + chargeur + coffret, propulsion linéaire 32 jusqu'à 40 kN  
 Kit: Akku-Pressmaschine, lineare Schubkraft 32 bis 40 kN

Article number	Box	Type
M-BA03	1 pc.	Battery

**Type: M-BOXBA03**



Case for M-BA03  
 Koffer voor M-BA03  
 Coffre pour M-BA03  
 Koffer für M-BOXBA03

Article number	Box	Type
M-BOXBA03	1 pc.	BOX M-BA03

**Type: M-BAT03**



Battery for M-BA03  
 Accu voor M-BA03  
 Batterie pour M-BA03  
 Akku für M-BA03

Article number	Box	Type
M-BAT03	1 pc.	Battery

- 1
- 2
- 3
- 4
- 5
- 6
- 7
- 8
- 9
- 10
- 11
- 12



# Henco Tools

Pressing Tools

1

## Type: M-LAD03

2

3

4

5

6



Charge-unit for M-BA03  
Lader voor M-BA03  
Chargeur pour M-BA03  
Akku-Ladegerät für M-BA03

Article number	Box	Type
M-LAD03	1 pc.	Charger

7

## Type: M-TRANS

8

9



Main adapter for M-BA03  
Adapter voor netaansluiting M-BA03  
Adaptateur raccordement au réseau M-BA03  
Netzadapter für M-BA03

Article number	Box	Type
M-TRANS03	1 pc.	Adapter

10

11

12

## Type: M-BHY162026



Kit : 230V hydraulic press machine with 16, 20, 26 jaws + metal case (110 volt also available), linear drive 32 to 40 kN  
Kit : Elektrisch-hydraulische persmachine + bekken 16, 20, 26 + koffer, linaire aandrijving 32 tot 40kN  
Kit: machine à sertir électro-hydraulique + pinces 16, 20, 26 + coffret, propulsion linéaire 32 jusqu'à 40 kN  
Kit : Elektrohydraulische Pressmaschine + Pressbacken 16, 20, 26 + Koffer, lineare Schubkraft 32 bis 40 kN

Article number	Box	Type
M-BHY162026	1 pc.	Wired 230V

## Type: M-BHY



Kit : 230V hydraulic press machine + metal case (110 volt also available), linear drive 32 to 40 kN  
Kit : Elektrisch-hydraulische persmachine + koffer, linaire aandrijving 32 tot 40kN  
Kit: machine à sertir électro-hydraulique + coffret, propulsion linéaire 32 jusqu'à 40 kN  
Kit : Elektrohydraulische Pressmaschine + Koffer, lineare Schubkraft 32 bis 40 kN

Article number	Box	Type
M-BHY	1 pc.	Wired 230V





## Type: M-BOXBHY



Metal case for M-BHY162026  
Koffer voor M-BHY162026  
Coffret en métal pour M-BHY162026  
Koffer für M-BHY162026

Article number	Box	Type
M-BOXBHY	1 pc.	Box M-BHY162026

## Type: BE



Jaws (universal)  
Persbekken (universeel)  
Plnces à sertir (universel)  
Pressbacken (universal)

Article number	Box	Type
BE14	1 pc.	BE/TH 14x2
BE16	1 pc.	BE/TH 16x2
BE18	1 pc.	BE/TH 18x2
BE20	1 pc.	BE/TH 20x2
BE26	1 pc.	BE/TH 26x3
BE32	1 pc.	BE 32x3
BE40	1 pc.	BE 40x3,5
BE50	1 pc.	BE 50x4
BE63	1 pc.	BE 63x4,5

*Press tool compatibilty: see [www.henco.be](http://www.henco.be)*

## Type: BE-UNISSET1



Set with universal jaw mounting unit and inserts  
Set met universele moederbek en wisselbekken  
Set avec pince mère universel et pinces  
Set mit Mutterpressbacke universal und Backen

Article number	Box	Type
BE-UNISSET1	1 pc.	16, 20 & 26mm

*Press tool compatibilty: see [www.henco.be](http://www.henco.be)*

## Type: BE-UNISSET2



Set with universal jaw mounting unit and BE-H inserts Ø14, 16, 18, 20, 26, and 32  
Set met universele moederbek en wisselbekken BE-H Ø14, 16, 18, 20, 26 en 32  
Set avec pince mère universel et pinces BE-H Ø14, 16, 18, 20, 26, et 32  
Set mit Mutterpressbacke universal und Backen BE-H Ø14, 16, 18, 20, 26, und 32

Article number	Box	Type
BE-UNISSET2	1 pc.	14, 16, 18, 20, 26 & 32mm

*Press tool compatibilty: see [www.henco.be](http://www.henco.be)*



## Henco Tools

Pressing Tools

### Type: BE-UNISETMINI3



Set with jaw be-mini3 + be-h inserts ø16,20,26,32  
 set met moederbek be-mini3 en wisselbekken be-h ø16, 20, 26 en 32  
 set avec pince mère be-mini3 + pinces be-h ø16,20,26,32  
 set mit mutterpressbacke be-mini3 + backen be-h ø16,20,26,32

Article number	Box	Type
BE-UNISETMINI3	1 pc.	16, 20, 26 & 32mm

*Press tool compatibility: see [www.henco.be](http://www.henco.be)*

### Type: TOOLBOX16202632



Box with KS16 20 26 32 M, BE-UNI, BE16 20 26 32 H, BI-1612, BI-2016, BA-1612, BA-2016, RS1420PRESS, SAFECUT  
 Koffer met KS16 20 26 32 M, BE-UNI, BE16 20 26 32 H, BI-1612, BI-2016, BA-1612, BA-2016, RS1420PRESS, SAFECUT  
 Coffre avec KS16 20 26 32 M, BE-UNI, BE16 20 26 32 H, BI-1612, BI-2016, BA-1612, BA-2016, RS1420PRESS, SAFECUT  
 Koffer mit KS16 20 26 32 M, BE-UNI, BE16 20 26 32 H, BI-1612, BI-2016, BA-1612, BA-2016, RS1420PRESS, SAFECUT

Article number	Box	Type
TOOLBOX16202632	1 pc.	16, 20, 26 & 32mm

*Press tool compatibility: see [www.henco.be](http://www.henco.be)*

### Type: TOOLBOX405063



Box with KS40M, KS50, KS63, BE40 50 63, RS63  
 Koffer met KS40M, KS50, KS63, BE40 50 63, RS63  
 Coffre avec KS40M, KS50, KS63, BE40 50 63, RS63  
 Koffer mit KS40M, KS50, KS63, BE40 50 63, RS63

Article number	Box	Type
TOOLBOX405063	1 pc.	40, 50 & 63mm

*Press tool compatibility: see [www.henco.be](http://www.henco.be)*

### Type: BE-UNI



Jaw mounting unit for M-BA03 and M-BHY, to be used with BE-H jaws  
 Moederbek voor M-BA03 en M-BHY en te gebruiken met BE-H bekken  
 Pince mère pour M-BA03 et M-BHY, à utiliser avec pinces BE-H  
 Mutterpressbacke für M-BA03 und M-BHY, zu verwenden mit BE-H Backen

Article number	Bag / Big Box	Type
BE-UNI	1 pc. / 12 pc.	MOTHER JAW

*BE-UNI is designed to press Henco press fittings, the interchangeable dies with M- and V-profile make it possible to make the transition from other materials to Henco other than Henco branded fittings with compact measurements can cause complex manipulation.*



## Type: BE-H



Inserts for BE-UNI, BE-MINI2, BE-MINI3, M-BH  
 Wisselbekken voor BE-UNI, BE-MINI2, BE-MINI3, M-BH  
 Pincés pour BE-UNI, BE-MINI2, BE-MINI3, M-BH  
 Pressbacken für BE-UNI, BE-MINI2, BE-MINI3, M-BH

Article number	Bag	Type
BE14H	1 Set (2pc.)	BE/TH 14X2 H
BE16H	1 Set (2pc.)	BE/TH 16X2 H
BE18H	1 Set (2pc.)	BE/TH 18X2 H
BE20H	1 Set (2pc.)	BE/TH 20X2 H
BE26H	1 Set (2pc.)	BE/TH 26X3 H
BE32H	1 Set (2pc.)	BE 32X3 H

*Our warranty does not apply to other pipe systems with M or V profile*

## Type: BE-HC



Inserts (copper) for BE-UNI, BE-MINI2, BE-MINI3, M-BH  
 Wisselbekken (koper) voor BE-UNI, BE-MINI2, BE-MINI3, M-BH  
 Pincés (cuivre) pour BE-UNI, BE-MINI2, BE-MINI3, M-BH  
 Pressbacken (Kupfer) für BE-UNI, BE-MINI2, BE-MINI3, M-BH

Article number	Box	Type
BE12HC	1 Set (2pc.)	12Cu V-profile
BE14HC	1 Set (2pc.)	14Cu V-profile
BE15HC	1 Set (2pc.)	15Cu V-profile
BE16HC	1 Set (2pc.)	16Cu V-profile
BE18HC	1 Set (2pc.)	18Cu V-profile
BE22HC	1 Set (2pc.)	22Cu V-profile
BE28HC	1 Set (2pc.)	28Cu V-profile

*Our warranty does not apply to other pipe systems with M or V profile*

## Type: BE-HM



Inserts (copper) for BE-UNI, BE-MINI2, BE-MINI3, M-BH  
 Wisselbekken (koper) voor BE-UNI, BE-MINI2, BE-MINI3, M-BH  
 Pincés (cuivre) pour BE-UNI, BE-MINI2, BE-MINI3, M-BH  
 Pressbacken (Kupfer) für BE-UNI, BE-MINI2, BE-MINI3, M-BH

Article number	Box	Type
BE12HM	1 Set (2pc.)	12Cu M-profile
BE15HM	1 Set (2pc.)	15Cu M-profile
BE18HM	1 Set (2pc.)	18Cu M-profile
BE22HM	1 Set (2pc.)	22Cu M-profile

*Our warranty does not apply to other pipe systems with M or V profile*

## Type: BE-BOX



Metal case for 6 compression jaws  
 Stalen koffer voor 6 persbekken  
 Coffret en métal pour 6 pincés à sertir  
 Stahlblechkasten für 6 Pressbacken

Article number	Box	Type
BE-BOX	1 pc.	BOX



## Henco Tools

Pressing Tools

### Type: M-BMINI3-F



Kit : compact rechargable battery press machine with press monitoring + case + charge unit + battery 18V + full jaws TH16-20-26, linear drive ca. 19 kN

Kit: hydraulische accu-persmachine met persbewaking + koffer + lader + 1 accu 18V + volle bekken TH16-20-26, lineaire aandrijving ca. 19kN

Kit : machine à sertir hydraulique + boîte + chargeur + batterie 18V, pince TH16-20-26, propulsion linéaire ca.19 kN

Kit: Hydraulisches Akku-Presswerkzeug mit Pressdrucküberwachung + Koffer + Ladegerät + 1 Akku 18V + Pressbacken TH16-20-26, lineare Schubkraft ca. 19 kN

Article number	Box	Type
M-BMINI3-F	1 pc.	Battery

### Type: M-BMINI3



Hydraulic press machine with battery 18V and linear drive 19kN

Hydraulische persmachine met batterij 18V en lineaire aandrijving 19kN

Machine à sertir hydraulique avec batterie 18V et propulsion linéaire 19kN

Hydraulisches Akku-presswerkzeug mit Akku 18V und lineare Schubkraft 19kN

Article number	Box	Type
M-BMINI3	1 pc.	Battery

### Type: M-BMINI3-S



Kit : compact rechargable battery press machine with press monitoring + case + charge unit + battery 18V, linear drive ca. 19 kN

Kit: hydraulische accu-persmachine met persbewaking + koffer + lader + 1 accu 18V, lineaire aandrijving ca. 19kN

Kit : machine à sertir hydraulique + boîte + chargeur + batterie 18V, propulsion linéaire ca.19 kN

Kit: Hydraulisches Akku-Presswerkzeug mit Pressdrucküberwachung + Koffer + Ladegerät + 1 Akku 18V, lineare Schubkraft ca. 19 kN

Article number	Box	Type
M-BMINI3-S	1 pc.	Battery



**Type: M-BATMINI3**



**Battery 18V for M-BMINI3**  
**Accu 18V voor M-BMINI3**  
**Batterie 18V pour M-BMINI3**  
**Akku 18V für M-BMINI3**

Article number	Box	Type
M-BATMINI3-2.0AH	1 pc.	18V / 2,0 Ah Li-ion
M-BATMINI3-5.0AH	1 pc.	18V / 5,0 Ah Li-ion

**Type: M-LADMINI3**



**Charge-unit for M-BMINI3 (-S and -F) + 5m cable**  
**Lader voor M-BMINI3 (-S and -F) + 5m kabel**  
**Chargeur pour M-BMINI3 (-S and -F) + 5m cable**  
**Akku-Ladegerät für M-BMINI3 (-S and -F) + 5m Kabel**

Article number	Box	Type
M-LADMINI3	1 pc.	CHARGER

**Type: M-TRANSMINI3**



**Mains adapter for press machines M-BMINI3 (-S and -F) + 5m cable**  
**Adapter voor netaansluiting M-BMINI3 (-S and -F) + 5m kabel**  
**Adaptateur raccordement au réseau M-BMINI3 (-S and -F) + 5m cable**  
**Netzadapter für M-BMINI3 (-S and -F) + 5m Kabel**

Article number	Box	Type
M-TRANSMINI3	1 pc.	Adapter

**Type: M-BOXMINI3**



**Metal case for M-BMINI3**  
**Koffer in metaal voor M-BMINI3**  
**Coffret en métal pour M-BMINI3**  
**Koffer in Metal für M-BMINI3**

Article number	Box	Type
M-BOXMINI3	1 pc.	CASE

**Type: M-BOXMINI3-F**



**Metal case for M-BMINI3-F**  
**Koffer in metaal voor M-BMINI3-F**  
**Coffret en métal pour M-BMINI3-F**  
**Koffer in Metal für M-BMINI3-F**

Article number	Box	Type
M-BOXMINI3-F	1 pc.	CASE

- 1
- 2
- 3
- 4
- 5
- 6
- 7
- 8
- 9
- 10
- 11
- 12



# Henco Tools

Pressing Tools

## Type: BE-MINI3



Jaw mounting unit for press machine M-BMINI3 and to be used for BE-H jaws  
 Moederbek voor persmachine M-BMINI3 en te gebruiken voor BE-H bekken  
 Pince mère pour machine à sertir M-BMINI3 et à utiliser pour pinces BE-H  
 Mutterpressbacke für Presswerkzeug M-BMINI3, zu verwenden mit BE-H Backen

Article number	Box	Type
BE-MINI3	1 pc.	MOTHER JAW

Press pool compatibility: [www.henco.be](http://www.henco.be)

## Type: BE..-MINI3



Jaw for press machine M-BMINI3 - TH/BE profile  
 Bek voor persmachine M-BMINI3 - TH/BE profiel  
 Pince pour machine à sertir M-BMINI3 - Profil TH/BE  
 Pressbacke für Presswerkzeuge M-BMINI3 + Profil TH/BE

Article number	Box	Type
BE14MINI3	1 pc.	BE/TH Ø14
BE16MINI3	1 pc.	BE/TH Ø16
BE20MINI3	1 pc.	BE/TH Ø20
BE26MINI3	1 pc.	BE/TH Ø26
BE32MINI3	1 pc.	BE Ø32

Press pool compatibility: [www.henco.be](http://www.henco.be)

## Type: BE.V-MINI3



Jaw for press machine M-BMINI3 - V-profile  
 Bek voor persmachine M-BMINI3 - V-profiel  
 Pince pour machine à sertir M-BMINI3 - Profil V  
 Pressbacke für Presswerkzeuge M-BMINI3 - Profil V

Article number	Box	Type
BE15V-MINI3	1 pc.	V-profile 15mm
BE18V-MINI3	1 pc.	V-profile 18mm
BE22V-MINI3	1 pc.	V-profile 22mm
BE28V-MINI3	1 pc.	V-profile 28mm

Our warranty does not apply to other pipe systems with M or V profile.  
 Press pool compatibility: [www.henco.be](http://www.henco.be)

## Type: BE.M-MINI3



Jaw for press machine M-BMINI3 - M-profile  
 Bek voor persmachine M-BMINI3 - M-profiel  
 Pince pour machine à sertir M-BMINI3 - Profil M  
 Pressbacke für Presswerkzeuge M-BMINI3 - Profil M

Article number	Box	Type
BE12M-MINI3	1 pc.	M-profile 12mm
BE15M-MINI3	1 pc.	M-profile 15mm
BE18M-MINI3	1 pc.	M-profile 18mm
BE22M-MINI3	1 pc.	M-profile 22mm
BE28M-MINI3	1 pc.	M-profile 28mm

Our warranty does not apply to other pipe systems with M or V profile.  
 Press pool compatibility: [www.henco.be](http://www.henco.be)



## Type: M-BATMINI2



Battery 18V / 1,5 Ah Li-ion for M-BMINI2  
 Accu 18V / 1,5 Ah Li-ion voor M-BMINI2  
 Batterie 18V / 1,5 Ah Li-ion pour M-BMINI2  
 Akku 18V / 1,5 Ah Li-ion für M-BMINI2

Article number	Box	Type
M-BATMINI2	1 pc.	18V / 1,5 Ah Li-ion

## Type: BE..-MINI



Jaw for press machine M-BMINI2(-S) and M-HP32  
 Bek voor persmachine M-BMINI2(-S) en M-HP32  
 Pince pour machine à sertir M-BMINI2(-S) et M-HP32  
 Pressbacke für Presswerkzeuge M-BMINI2(-S) und M-HP32

Article number	Box	Type
BE16MINI	1 pc.	BE/TH Ø16
BE20MINI	1 pc.	BE/TH Ø20
BE26MINI	1 pc.	BE/TH Ø26
BE32MINI	1 pc.	BE Ø32

*Not applicable to press machine type M-BMINI3*

## Type: BE..-MMINI



M-profile jaw (copper) for press machine M-BMINI(2)(-S) and M-HP32  
 M-profiel bek (koper) voor persmachine M-BMINI(2)(-S) en M-HP32  
 M-profil pince (cuivre) pour machine à sertir M-BMINI(2)(-S) et M-HP32  
 M-profil Pressbacke (Kupfer) für Presswerkzeuge M-BMINI(2)(-S) und M-HP32

Article number	Bag	Type
BE15MMINI	1 pc.	Ø15Cu M-Profil
BE22MMINI	1 pc.	Ø22Cu M-Profil

*Not applicable to press machine type M-BMINI3*

## Type: BE-C



V-profile jaw (copper) for press machine M-BMINI2(-S) and M-HP32  
 V-profiel persbek (koper) voor persmachine M-BMINI2(-S) and M-HP32  
 V-profil pince (cuivre) pour machine à sertir M-BMINI2(-S) et M-HP32  
 V-profil Pressbacke (Kupfer) für Presswerkzeuge M-BMINI2(-S) und M-HP32

Article number	Bag	Type
BE15C	1 pc.	Ø15Cu V-Profil
BE18C	1 pc.	Ø18Cu V-Profil
BE22C	1 pc.	Ø22Cu V-Profil
BE28C	1 pc.	Ø28Cu V-Profil

*Not applicable to press machine type M-BMINI3*

*Our warranty does not apply to other pipe systems with M or V profile.*

## Type: BE-MINI



Jaw mounting unit for press machine M-BMINI(2)(-S) / M-HP32 and to be used with BE-H jaws  
 Bek voor persmachine M-BMINI2(-S) en M-HP-32 en te gebruiken met BE-H persbeken  
 Pince mère pour machine à sertir M-BMINI(2)(-S) / M-HP32 et à utiliser avec pinces BE-H  
 Mutterpressbacke für Presswerkzeug M-BMINI(2)(-S) / M-HP32, zu verwenden mit BE-H Backen

Article number	Box	Type
BE-MINI	1 pc.	MOTHERJAW

*BE-MINI is designed to press Henco press fittings, the interchangeable dies with M- and V-profile make it possible to make the transition from other materials to Henco; other than Henco branded fittings with compact measurements can cause complex manipulation*



# Henco Tools

Pressing Tools

1 **Type: M-HP**



Hydraulic manual press tool + bag  
 Hydraulisch handpersmachine + draagtas  
 Machine à sertir manuelle hydraulique + sac  
 Hydraulisches Handpressmaschine + Tasche

Article number	Bag	Type
M-HP32	1 pc.	Ø14-32

7 **Type: M-BH**



Kit: manual press machine + inserts 16,20,26 + bag  
 Kit: handpersmachine + bekken 16, 20, 26 + draagtas  
 Kit: machine à sertir manuelle + pinces 16, 20, 26 + sac  
 Kit: Handpressmaschine + Pressbacken 16, 20, 26 + Tasche

Article number	Bag	Type
M-BH162026	1 pc.	Ø16-20-26

*Not for intensive use*

12 **Type: M-BM1620**



Kit: manual press machine with 16, 20 jaws  
 Kit: handpersmachine + wisselbekken 16, 20  
 Kit: machine à sertir manuelle + pinces 16, 20  
 Kit: Handpressmaschine + Pressbacken 16, 20

Article number	Bag	Type
M-BM1620	1 pc.	Ø16-20 mm

**Type: BE-M**



Inserts for M-BM1620  
 Wisselbekken voor M-BM1620  
 Pinces pour M-BM1620  
 Pressbacken für M-BM1620

Article number	Bag	Type
BE14M	1 pc.	BE/TH 14X2
BE16M	1 pc.	BE/TH 16X2
BE18M	1 pc.	BE/TH 18X2
BE20M	1 pc.	BE/TH 20X2





## Type: HNTOOLSET



Toolset for the SUPER SIZES range  
 Toolset voor het SUPER SIZES gamma  
 Set d'outil pour la gamme SUPER SIZES  
 Toolset für das SUPER SIZES Angebot

Article number	Box	Type
HNTOOLSET	1 pc.	Super Sizes

## Type: PRESSCHECK



Tool to control the accuracy of a pressing  
 Instrument om correctheid v/e persing te controleren  
 Outil pour contrôler la précision d'un sertissage  
 Instrument zur Überprüfung ob die Pressung korrekt ausgeführt

Article number	Bag / Box	Type
PRESSCHECK1432	1 pc. / 200 pc.	Ø14-32

## Type: DRILLY



Drilly temporary air vent plug, reusable  
 Drilly voor afdrukken leidingssysteem, herbruikbaar  
 Drilly pour tester le système de tubes, réutilisable  
 Drilly zum abdrucken Rohresysteme, wieder verwendbar

Article number	Box	Type
DRILLY14	1 pc.	Ø14
DRILLY16	1 pc.	Ø16
DRILLY20	1 pc.	Ø20
DRILLY26	1 pc.	Ø26
DRILLY32	1 pc.	Ø32

## Type: PLUG



Plug  
 Afdrukplug  
 Bouchon  
 Stopf

Article number	Box / Big Box	Type
PLUG04-B80	20 pc. / 360 pc.	1/2" - 80 mm blue
PLUG04-R80	20 pc. / 360 pc.	1/2" - 80 mm red
PLUG05-B80	20 pc. / 160 pc.	3/4" - 80 mm blue
PLUG05-R80	20 pc. / 160 pc.	3/4" - 80 mm red



# Henco Tools

Pressing Tools

## Type: PK-TOOL



Wrench for PK/SK fittings with threading  
 Sleutel voor PK/SK fittings met draad  
 Clé pour raccords PK/SK fitage  
 Schlüssel für PK/SK Fittings mit Draht

Article number	Box / Big Box	Type
PK-TOOL04	1 pc. / 50 pc.	1/2"
PK-TOOL05	1 pc. / 50 pc.	3/4"
PK-TOOL06	1 pc. / 50 pc.	1"

### Characteristics PK-TOOL

- ▶ Light weight ratchet key
- ▶ Full grip around fitting profile
- ▶ Plastic body stays intact, even when applying extreme torque
- ▶ Key works as well in clock- as counterclockwise direction
- ▶ Maximum torque transition
- ▶ Size indication on handle
- ▶ Chromed handle
- ▶ Key gripping jaws in anodized aluminum
- ▶ Possibility to grip around mounted fittings due to specific closing mechanism



## Type: PK-TOOLBOX-040506



Set Wrenches for PK/SK Fittings 1/2" - 1" Threading  
 Set sleutels voor PK/SK fittings 1/2" tot 1" draad  
 Set Clés pour raccords PK/SK fitage 1/2" - 1"  
 Set Schlüssel für PK/SK Fittings 1/2" bis 1" Draht

Article number	Box	Type
PK-TOOLBOX-040506	1 pc.	CASE

## Type: PK-TOOLBOX



Empty plastic case for PK-TOOL04/05/06  
 Set sleutels voor PK/SK fittings 1/2" tot 1" draad  
 Coffret pour PK-TOOL04/05/06  
 Koffer für PK-TOOLBOX04/05/06

Article number	Box / Big Box	Type
PK-TOOLBOX	1 pc. / 10 pc.	CASE



**Type: UFH-VLA**



Decoiler, Standard model  
Haspel, basismodel  
Machine à dérouler, Standard  
Abwickelmaschine, Standard

Article number	Box	Type
UFH-VLA	1 pc.	25m -600m

*Minimum inner diameter coil: 140mm*

**Type: UFH-VLA-STR**



Pipe straightener for decoiler UFH-VLA 14-26mm  
Stangenrechter voor haspel UFH-VLA 14-26mm  
Machine à produire des barres pour dérouler UFH-VLA 14-26mm  
Stangenmaschine für Wickelmaschine UFH-VLA 14-26mm

Article number	Box	Type
UFH-VLA-STR	1 pc.	14-26mm

**Type: UFH-TACK**



Tacker machine for UFH-TACK-40, UFH-TACK-60  
Tackerapparaat voor UFH-TACK-40, UFH-TACK-60  
Appareil Tacker pour UFH-TACK-40, UFH-TACK-60  
Tackergerät für UFH-TACK-40, UFH-TACK-60

Article number	Box	Type
UFH-TACK	1 pc.	for UFH-TACK-40 / UFH-TACK-60

- 1
- 2
- 3
- 4
- 5
- 6
- 7
- 8
- 9
- 10
- 11
- 12



## Henco Tools

Underfloor Heating Tools

1 **Type: UFH-RAS-VLE**



**Braid hook**  
**Vlechthaak**  
**Crochet de tressage**  
**Gerät zum Flechten von Stahldraht**

Article number	Box	Type
UFH-RAS-VLE	1 pc.	

2  
3  
4  
5  
6 **Type: UFH-RAS-CUT**



**Cutter for steel mesh**  
**Kniptang voor stalen draadmatten**  
**Pince coupante pour treillis**  
**Schere für Trägermatte**

Article number	Box	Type
UFH-RAS-CUT	1 pc.	

7  
8  
9  
10  
11  
12

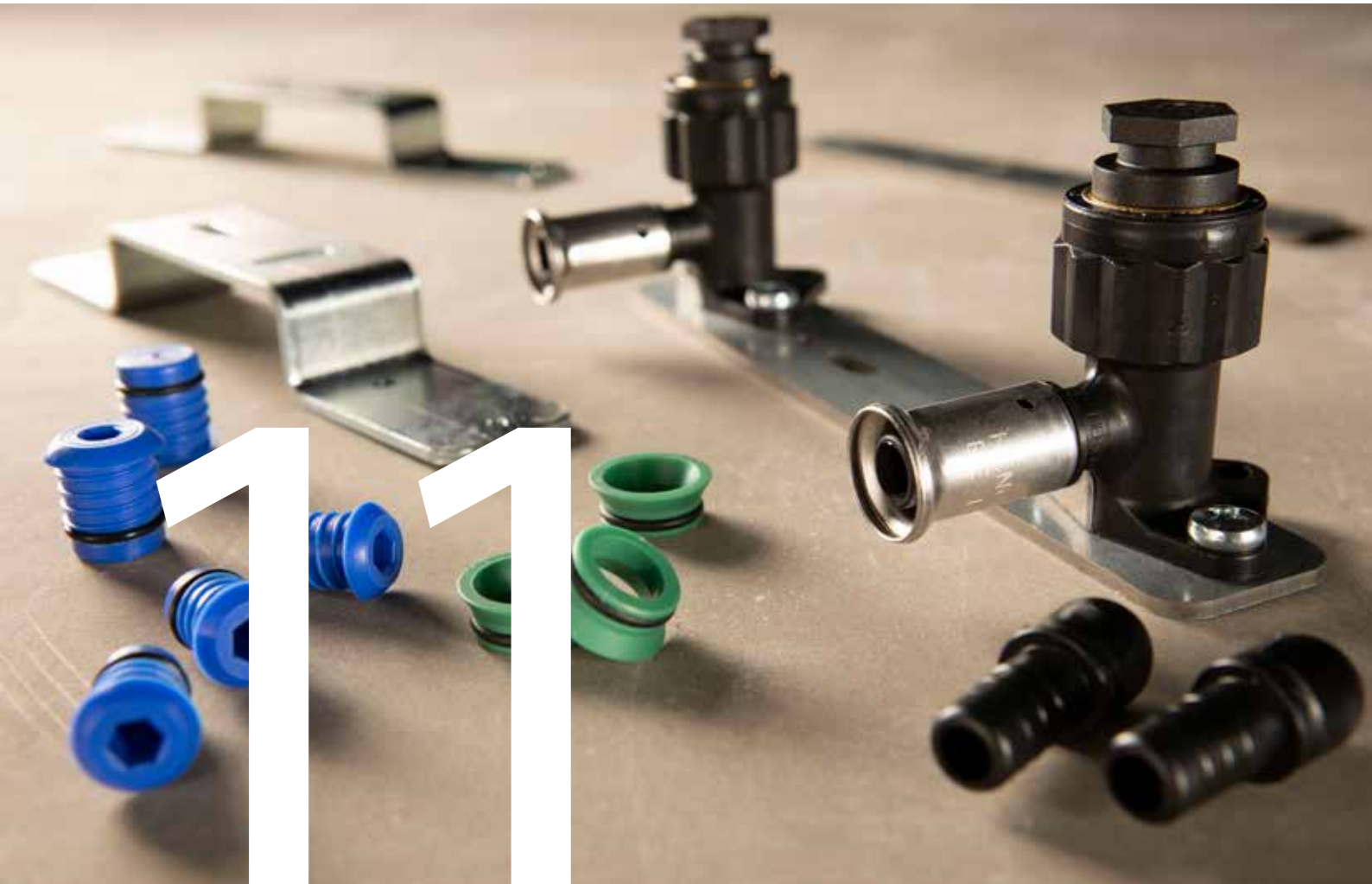



## Henco Accessories

### Type: BCLIP



Clip-it clip for Henco pipes, single  
 Clip-it beugel voor Henco buizen, enkel  
 Clip-it attache de fixation pour tubes henco, simple  
 Clip-it Bügel für Henco Rohre, einfach

Article number	Box	Type
BCLIP-16	100 pc.	Ø16
BCLIP-1820	100 pc.	Ø18 - 20
BCLIP-26	100 pc.	Ø26
BCLIP-32	100 pc.	Ø32
BCLIP-40*	100 pc.	Ø40
BCLIP-50*	50 pc.	Ø50

*\*TILL EXHAUSTION OF STOCK*

### Type: JCLIP



J-clip pipe clips, single  
 J-clip beugels, enkel  
 Attaches de fixation J-clip, simple  
 J-clip Haken, einfach

Article number	Box	Type
JCLIP-1632	200 pc.	Ø16-32, 70 mm

### Type: JCLIP L



J-clip pipe clips, single, long  
 J-clip beugels, enkel, lang  
 Attaches de fixation J-clip, simple, long  
 J-clip Haken, einfach, lang

Article number	Box	Type
JCLIP-1632L	200 pc.	Ø16-32, 97 mm

### Type: JCLIP DOUBLE



J-clip pipe clips, double  
 J-clip beugels, dubbel  
 Attaches de fixation J-clip, double  
 J-clip Haken, doppelt

Article number	Box	Type
JCLIP-1632D	200 pc.	Ø16-32, 70 mm

### Type: JCLIP DOUBLE L



J-clip pipe clips, double long  
 J-clip beugels, dubbel lang  
 Attaches de fixation J-clip, double long  
 J-clip Haken, doppelt lang

Article number	Box	Type
JCLIP-1632DL	200 pc.	Ø16-32, 97 mm



## Type: PIPEPLUG



Protection cap for pipe  
 Beschermstopje voor buis  
 Capuchon de protection pour tube  
 Schutzkappe für Rohr

Article number	Bag / Box	Type
PIPEPLUG16	100 pc. / 700 pc.	Ø 16
PIPEPLUG20	100 pc. / 500 pc.	Ø 20
PIPEPLUG26	100 pc. / 300 pc.	Ø 26

## Type: PLP-P-PK



Galvanised bracket for backplate elbow  
 Gebogen tappuntbeugel gegalvaniseerd  
 Support galvanisé pour culasse sanitaire  
 Halteplatte galvanisiert

Article number	Bag / Box	Type
PLP-P-PK	1 pc. / 20 pc.	ELBOW

*Interaxis 153mm*

## Type: PLF-P-PK



Galvanised bracket flat for backplate elbow  
 Vlakke tappuntbeugel gegalvaniseerd  
 Support galvanisé pour culasse sanitaire  
 Halteplatte flach galvanisiert

Article number	Bag / Box	Type
PLF-P-PK	1 pc. / 40 pc.	FLAT

*Interaxis 120mm and 153mm*

## Type: TESTPLUG



Testcap blue for Henco pipe  
 Kunststof afpersplug blauw voor Henco buis  
 Capuchon de teste blue pour tube  
 Testkappe blau für Rohr

Article number	Bag / Box	Type
TESTPLUG16	20 pc. / 4000 pc.	Ø16
TESTPLUG20	20 pc. / 2000 pc.	Ø20
TESTPLUG26	20 pc. / 1000 pc.	Ø26

## Type: TESTPLUG-RO



Testcap red for Henco pipe  
 Kunststof afpersplug rood voor Henco buis  
 Capuchon de teste rouge pour tube  
 Testkappe roth für Rohr

Article number	Bag / Box	Type
TESTPLUG16-RO	20 pc. / 4000	Ø16
TESTPLUG20-RO	20 pc. / 2000	Ø20
TESTPLUG26-RO	20 pc. / 1000	Ø26

**NEW\***  
 PRODUCT



## Henco Accessories

### Type: AK-EK



Adapter from 3/4" EK to flat sealing  
 Adapter kunststof - EK 3/4" naar vlakdichtend  
 Adapteur EK 3/4" vers joint plat  
 Adapter von EK 3/4" nach AG Flachdichtend

Article number	Bag / Big Box	Type
AK-EK05VD	50 pc. / 1000 pc.	

### Type: BD



Montage-/hersteltape  
 Montage-/hersteltape  
 Montage-/hersteltape  
 Montage-/hersteltape

Article number	Box	Type
BDR33M	36 pc.	33m x 50mm / Red
BDB33M	36 pc.	33m x 50mm / Blue

### Type: HFMAN



EPDM sleeve for hencoflex  
 EPDM manchette hencoflex  
 Manchon EPDM pour hencoflex  
 EPDM Hülse für Hencoflex

Article number	Bag / Box	Type
HFMAN125	1 pc. / 30 pc.	

**NEW**  
PRODUCT





	<i>Page</i>
<i>Sprinkler Standard (PE-Xc/AL/PE-Xc) Pipes</i>	<i>162</i>
<i>Henco Press Sprinkler</i>	<i>163</i>
<i>Henco Pro-Sprinkler</i>	<i>169</i>
<i>Sprinkler Tools</i>	<i>173</i>



# Henco Sprinkler

SPRINKLER STANDARD (PE-Xc/AL/PE-Xc) Pipes

## 1 Type: STRAIGHT LENGTH SPR



Henco multilayer pipe SPRINKLER (Straight length)  
Henco meerlagenbuis SPRINKLER (Stang)  
Henco tube multicouche SPRINKLER (Barre)  
Henco Mehrschichtverbundrohr SPRINKLER (Stange)

Article number	Cylinder / Pallet	Type
05-320326-SPR	35 m / 1680 m	32x3
05-403533-SPR	45 m / 1080 m	40x3,5
05-504042-SPR	35 m / 840 m	50x4
05-634554-SPR	20 m / 480 m	63x4,5

## 8 Type: COIL SPR



Henco multilayer pipe SPRINKLER (Coil)  
Henco meerlagenbuis SPRINKLER (rol)  
Henco tube multicouche SPRINKLER (Rouleau)  
Henco Mehrschichtverbundrohr SPRINKLER (Rohr)

Article number	Coil / Pallet	Type
50-320326-SPR	50 m / 650 m	32x3



## Type: 1PKS



Elbow 90°  
Knie 90°  
Coude 90°  
Winkel 90°

Article number	Bag / Box	Type
1PKS-3232	5 pc. / 30 pc.	32x32
1PKS-4040	5 pc. / 20 pc.	40x40
1PKS-5050	1 pc. / 8 pc.	50x50
1PKS-6363	1 pc. / 6 pc.	63x63

## Type: 5PKS (CW617)



Elbow 90° male adapter  
Knie 90° buitendraad  
Coude 90° mâle  
Winkel 90° AG

Article number	Bag / Box	Type
5PKS-3206	5 pc. / 20 pc.	32x1"
5PKS-4007	3 pc. / 15 pc.	40x5/4"
5PKS-5007	1 pc. / 10 pc.	50x1 1/4"
5PKS-5008	1 pc. / 8 pc.	50x6/4"
5PKS-6310	1 pc. / 4 pc.	63x2"

## Type: 5PKS-N (CW602)



Elbow 90° male adapter CW602  
Knie 90° buitendraad CW602  
Elbow 90° male adapter CW602  
Elbow 90° male adapter CW602

Article number	Bag / Box	Type
5PKS-3206-N	5 pc. / 20 pc.	32x1"
5PKS-4007-N	3 pc. / 15 pc.	40x5/4"
5PKS-5007-N	1 pc. / 10 pc.	50x5/4"
5PKS-5008-N	1 pc. / 8 pc.	50x6/4"
5PKS-6310-N	1 pc. / 4 pc.	63x2"

## Type: 6PKS (CW617)



Elbow 90° female adapter  
Knie 90° binnendraad  
Coude 90° femelle  
Winkel 90° IG

Article number	Bag / Box	Type
6PKS-3204	5 pc. / 20 pc.	32x1/2"
6PKS-3206	5 pc. / 20 pc.	32x1"
6PKS-4004	5 pc. / 15 pc.	40x1/2"
6PKS-4007	5 pc. / 15 pc.	40x5/4"
6PKS-5004	1 pc. / 8 pc.	50x1/2"
6PKS-5007	1 pc. / 8 pc.	50x5/4"
6PKS-5008	1 pc. / 8 pc.	50x6/4"
6PKS-6304	1 pc. / 4 pc.	63x1/2"
6PKS-6310	1 pc. / 4 pc.	63x2"

- 1
- 2
- 3
- 4
- 5
- 6
- 7
- 8
- 9
- 10
- 11
- 12



# Henco Sprinkler

Henco Press SPRINKLER

## Type: 6PKS-N (CW602)



Elbow 90° female adapter  
Knie 90° binnendraad  
Elbow 90° female adapter  
Elbow 90° female adapter

Article number	Bag / Box	Type
6PKS-3204-N	5 pc. / 20 pc.	32x1/2"
6PKS-3206-N	5 pc. / 20 pc.	32x1"
6PKS-4004-N	5 pc. / 15 pc.	40x1/2"
6PKS-4007-N	5 pc. / 15 pc.	40x5/4"
6PKS-5004-N	1 pc. / 8 pc.	50x1/2"
6PKS-5007-N	1 pc. / 8 pc.	50x5/4"
6PKS-5008-N	1 pc. / 8 pc.	50x6/4"
6PKS-6304-N	1 pc. / 4 pc.	63x1/2"
6PKS-6310-N	1 pc. / 4 pc.	63x2"

## Type: 9PKS



T-piece  
T-stuk  
Pièce en T  
T-Stück

Article number	Bag / Box	Type
9PKS-323232	5 pc. / 15 pc.	32x32x32
9PKS-404040	5 pc. / 10 pc.	40x40x40
9PKS-505050	1 pc. / 6 pc.	50x50x50
9PKS-636363	1 pc. / 3 pc.	63x63x63

## Type: 10PKS



T-reduced centre  
T-verlopend  
Pièce en T réduit  
T-reduziert

Article number	Bag / Box	Type
10PKS-403240	5 pc. / 10 pc.	40x32x40
10PKS-503250	1 pc. / 8 pc.	50x32x50
10PKS-504050	1 pc. / 6 pc.	50x40x50
10PKS-633263	1 pc. / 3 pc.	63x32x63
10PKS-634063	1 pc. / 3 pc.	63x40x63
10PKS-635063	1 pc. / 3 pc.	63x50x63

## Type: 11PKS



T-branch and line reduced  
T-2x verlopend  
Pièce en T 2x réduit  
T-2x reduziert

Article number	Bag / Box	Type
11PKS-403232	5 pc. / 10 pc.	40x32x32
11PKS-404032	5 pc. / 10 pc.	40x40x32
11PKS-503240	1 pc. / 10 pc.	50x32x40
11PKS-504040	1 pc. / 8 pc.	50x40x40



## Type: 12PKS



T-enlarged branch  
T-vergroot  
Pièce en T agrandi  
T-erweitert

Article number	Bag / Box	Type
12PKS-324032	5 pc. / 15 pc.	32x40x32
12PKS-405040	1 pc. / 8 pc.	40x50x40

## Type: 13PKS (CW617)



T-female centre  
T-binnendraad  
Pièce en T femelle  
T-IG

Article number	Bag / Box	Type
13PKS-320432	5 pc. / 15 pc.	32x1/2"x32
13PKS-320532	5 pc. / 15 pc.	32x3/4"x32
13PKS-320632	5 pc. / 10 pc.	32x1"x32
13PKS-320732	5 pc. / 10 pc.	32x5/4"x32
13PKS-400440	5 pc. / 10 pc.	40x1/2"x40
13PKS-400640	5 pc. / 10 pc.	40x1"x40
13PKS-400740	5 pc. / 10 pc.	40x5/4"x40
13PKS-500450	1 pc. / 4 pc.	50x1/2"x50
13PKS-500550	1 pc. / 4 pc.	50x3/4"x50

## Type: 13PKS (CW617)



Article number	Bag / Box	Type
13PKS-500850	1 pc. / 4 pc.	50x6/4"x50
13PKS-630463	1 pc. / 2 pc.	63x1/2"x63
13PKS-631063	1 pc. / 2 pc.	63x2"x63

## Type: 13PKS-N (CW602)



T-female centre  
T-binnendraad  
T-female centre  
T-female centre

Article number	Bag / Box	Type
13PKS-320432-N	5 pc. / 15 pc.	32x1/2"x32
13PKS-320532-N	5 pc. / 15 pc.	32x3/4"x32
13PKS-320632-N	5 pc. / 10 pc.	32x1"x32
13PKS-320732-N	5 pc. / 10 pc.	32x5/4"x32
13PKS-400440-N	5 pc. / 10 pc.	40x1/2"x40
13PKS-400640-N	5 pc. / 10 pc.	40x1"x40
13PKS-400740-N	5 pc. / 10 pc.	40x5/4"x40
13PKS-500550-N	1 pc. / 4 pc.	50x3/4"x50
13PKS-500850-N	1 pc. / 4 pc.	50x6/4"x50
13PKS-630463-N	1 pc. / 2 pc.	63x1/2"x63
13PKS-631063-N	1 pc. / 2 pc.	63x2"x63



# Henco Sprinkler

Henco Press SPRINKLER

## Type: 14PKS (CW617)



T-male centre  
T-buitendraad  
Pièce en T mâle  
T-AG

Article number	Bag / Box	Type
14PKS-320532	5 pc. / 15 pc.	32x3/4"x32
14PKS-400640	5 pc. / 10 pc.	40x1"x40
14PKS-400740	5 pc. / 10 pc.	40x5/4"x40
14PKS-500850	1 pc. / 5 pc.	50x6/4"x50
14PKS-631063	1 pc. / 2 pc.	63x2"x63

## Type: 14PKS-N (CW602)



T-male centre  
T-buitendraad  
T-male centre  
T-male centre

Article number	Bag / Box	Type
14PKS-320532-N	5 pc. / 15 pc.	32x3/4"x32
14PKS-400640-N	5 pc. / 10 pc.	40x1"x40
14PKS-400740-N	5 pc. / 10 pc.	40x5/4"x40
14PKS-500850-N	1 pc. / 5 pc.	50x6/4"x50
14PKS-631063-N	1 pc. / 2 pc.	63x2"x63

## Type: 15PKS



Straight coupling  
Perssok  
Manchon  
Kupplung

Article number	Bag / Box	Type
15PKS-3232	5 pc. / 30 pc.	32x32
15PKS-4040	5 pc. / 25 pc.	40x40
15PKS-5050	1 pc. / 12 pc.	50x50
15PKS-6363	1 pc. / 9 pc.	63x63

## Type: 16PKS



Reducing coupling  
Verloopstuk  
Réduction  
Kupplung-reduziert

Article number	Bag / Box	Type
16PKS-4032	5 pc. / 25 pc.	40x32
16PKS-5032	1 pc. / 15 pc.	50x32
16PKS-5040	1 pc. / 15 pc.	50x40
16PKS-6340	1 pc. / 8 pc.	63x40
16PKS-6350	1 pc. / 8 pc.	63x50



## Type: 17PKS (CW617)



Straight male adapter  
Puntstuk  
Raccord droit mâle  
Übergangsfitting AG

Article number	Bag / Box	Type
17PKS-3206	10 pc. / 40 pc.	32x1"
17PKS-3207	5 pc. / 25 pc.	32x5/4"
17PKS-4006	5 pc. / 25 pc.	40x1"
17PKS-4007	5 pc. / 25 pc.	40x5/4"
17PKS-5008	1 pc. / 10 pc.	50x6/4"
17PKS-6310	1 pc. / 6 pc.	63x2"

## Type: 17PKS-N (CW602)



Straight male adapter  
Puntstuk  
Straight male adapter  
Straight male adapter

Article number	Bag / Box	Type
17PKS-3206-N	10 pc. / 40 pc.	32x1"
17PKS-3207-N	5 pc. / 25 pc.	32x5/4"
17PKS-4006-N	5 pc. / 25 pc.	40x1"
17PKS-4007-N	5 pc. / 25 pc.	40x5/4"
17PKS-5008-N	1 pc. / 10 pc.	50x6/4"
17PKS-6310-N	1 pc. / 6 pc.	63x2"

## Type: 18PKS (CW617)



Straight female adapter  
Recht aansluitstuk binnendraad  
Raccord droit femelle  
Übergangsfitting IG

Article number	Bag / Box	Type
18PKS-3204	10 pc. / 40 pc.	32x1/2"
18PKS-3206	10 pc. / 40 pc.	32x1"
18PKS-3207	5 pc. / 25 pc.	32x5/4"
18PKS-4006	5 pc. / 25 pc.	40x1"
18PKS-4007	5 pc. / 25 pc.	40x5/4"
18PKS-5008	1 pc. / 10 pc.	50x6/4"
18PKS-6310	1 pc. / 6 pc.	63x2"

## Type: 18PKS-N (CW602)



Straight female adapter  
Recht aansluitstuk binnendraad  
Straight female adapter  
Straight female adapter

Article number	Bag / Box	Type
18PKS-3204-N	10 pc. / 40 pc.	32x1/2"
18PKS-3206-N	10 pc. / 40 pc.	32x1"
18PKS-3207-N	5 pc. / 25 pc.	32x5/4"
18PKS-4006-N	5 pc. / 25 pc.	40x1"
18PKS-4007-N	5 pc. / 25 pc.	40x5/4"
18PKS-5008-N	1 pc. / 10 pc.	50x6/4"
18PKS-6310-N	1 pc. / 6 pc.	63x2"



# Henco Sprinkler

Henco Press SPRINKLER

1 **Type: 27PKS**



Elbow 45°  
Knie 45°  
Coude 45°  
Winkel 45°

Article number	Bag / Box	Type
27PKS-3232	5 pc. / 30 pc.	32x32
27PKS-4040	5 pc. / 25 pc.	40x40
27PKS-5050	1 pc. / 10 pc.	50x50
27PKS-6363	1 pc. / 5 pc.	63x63

7 **Type: 52PS**



Mounting/repair fitting  
Montage/reparatie fitting Sprinkler  
Raccord montage/reparation  
Montage/reparatur fitting

Article number	Bag / Box	Type
52PS32	1 pc. / 20 pc.	32x32

12 **Type: 53PKS**



Easymounting/repair fitting  
Montage/reparatie fitting Sprinkler  
Raccor montage/reparation  
Montage/reparatur fitting

Article number	Bag / Box	Type
53PKS40	1 pc. / 20 pc.	40x40
53PKS50	1 pc. / 9 pc.	50x50
53PKS63	1 pc. / 6 pc.	63x63

**Type: 50P**



Stainless steel sprinkler connection with stainless steel cup  
RVS instort sprinkler-aansluiting met RVS cup  
Raccord sprinkler en acier inoxydable avec coupelle en acier inoxydable  
Sprinkler-Anschluss aus Edelstahl mit Edelstahltasse

Article number	Bag / Box	Type	Height
50P-3206	1 pc. / 15 pc.	32x1"	23 mm
50P-320604	1 pc. / 15 pc.	32x1/2"	23 mm
50P-320605	1 pc. / 15 pc.	32x3/4"	23 mm
50P43-320604	1 pc. / 15 pc.	32x1"	40 mm





## Type: 6PKS-OP (CW617N)



T-female branch with pressure test plug  
 T-binnendraad met afpersplug  
 Pièce en T femelle avec bouchon pour essai de pression  
 T-IG mit Stopfen für für Prüfdruck

Article number	Bag / Box	Type
6PKS-3206OP	5 pc. / 20 pc.	32x1" + plug

## Type: 6PKS-OP-CS (CW724N)



T-female branch with pressure test plug (CW724N)  
 T-binnendraad met afpersplug (CW724N)  
 Pièce en T femelle avec bouchon pour essai de pression (CW724N)  
 T-IG mit Stopfen für für Prüfdruck (CW724N)

Article number	Bag / Box	Type
6PKS-3206OP-CS	5 pc. / 20 pc.	32x1" + plug

## Type: 13PKS-OP (CW617N)



T-female branch with pressure test plug  
 T-binnendraad met afpersplug  
 Pièce en T femelle avec bouchon pour essai de pression  
 T-IG mit Stopfen für für Prüfdruck

Article number	Bag / Box	Type
13PKS-320632OP	5 pc. / 10 pc.	32x1"x32 + plug

## Type: 13PKS-OP-CS (CW724N)



T-female branch with pressure test plug (CW724N)  
 T-binnendraad met afpersplug (CW724N)  
 Pièce en T femelle avec bouchon pour essai de pression (CW724N)  
 T-IG mit Stopfen für für Prüfdruck (CW724N)

Article number	Bag / Box	Type
13PKS-320632OP-CS	5 pc. / 10 pc.	32x1"x32 + plug

## Type: 18PKS-OP (CW617N)



Straight female adapter with pressure test plug  
 Recht aansluitstuk binnendraad met afpersplug  
 Raccord droit femelle avec bouchon pour essai de pression  
 Übergangsfitting IG mit Stopfen für für Prüfdruck

Article number	Bag / Box	Type
18PKS-3206OP	10 pc. / 40 pc.	32x1" + plug

## Type: 18PKS-OP-CS (CW724N)



Straight female adapter with pressure test plug (CW724N)  
 Recht aansluitstuk binnendraad met afpersplug (CW724N)  
 Raccord droit femelle avec bouchon pour essai de pression (CW724N)  
 Übergangsfitting IG mit Stopfen für für Prüfdruck (CW724N)

Article number	Bag / Box	Type
18PKS-3206OP-CS	10 pc. / 40 pc.	32x1" + plug



# Henco Sprinkler

Henco PRO-sprinkler

**NEW\***  
PRODUCT

## Type: SPR-OP



Pressure test plug with O-ring  
Afpersplug met O-ring  
Bouchon avec joint torique pour essai de pression  
Stopfen mit O-Ring für Prüfdruck

Article number	Bag / Box	Type
SPR-OP06	100 pc. / 800	1"

## Type: SPR-CBLOCK



Concrete sprinkler cup to embed  
Instort sprinklercup in beton  
Connexion sprinkler à encastrer en béton  
Sprinkler-Anschluss im Beton zum Eingiessen

Article number	Box	Type
SPR-CBLOCK	18 pc.	Height = 65 mm
SPR-CBLOCK80	16 pc.	Height = 80 mm

## Type: SPR-CBLOCK-WS



Concrete sprinkler cup to embed with insulation for wide slabs  
Instort sprinklercup in beton met isolatie voor breedplaten  
Connexion sprinkler à encastrer en béton avec isolation pour dalles alvéolées  
Sprinkler-Anschluss im Beton zum Eingiessen mit Isolierung für Plattendecke

Article number	Box	Type
SPR-CBLOCK80-WS	16 pc.	Height = 80 mm

## Type: SPR-CBLOCK-TF



Concrete sprinkler cup to embed with glue fixation for tunnel formwork  
Instort sprinklercup in beton met lijmfixatie voor tunnelbouw  
Connexion sprinkler à encastrer en béton avec fixation à coller pour coffrage de tunnel  
Concrete sprinkler cup to embed with glue fixation for tunnel formwork

Article number	Box	Type
SPR-CBLOCK-TF	18 pc.	Height = 65 mm

## Type: SPR-ISO-WS



Insulation for concrete sprinkler cup to embed for wide slabs  
Isolatie voor instort sprinklercup in beton voor breedplaten  
Isolation pour connexion sprinkler à encastrer en béton pour dalles alvéolées  
Isolierung für Sprinkler-Anschluss im Beton zum Eingiessen für Plattendecke

Article number	Bag / Box	Type
SPR-ISO-WS	9 pc. / 45 pc.	EPS



## Type: SPR-MAGNET

NEW PRODUCT



Magnet fixation  
Magneetfixatie  
Magnet fixation  
Magnet Fixierung

Article number	Box	Type
SPR-MAGNET26	720 pc.	Height = 26 mm
SPR-MAGNET31	400 pc.	Height = 31 mm

## Type: SPR-ISO-MAGNET

NEW PRODUCT



Insulation for magnet  
Isolatie voor magneet  
Isolation pour magnet  
Isolierung für Magnet

Article number	Box	Type
SPR-ISO-MAGNET26	480 pc.	PE

## Type: SPR-FIX

NEW PRODUCT



Fixation for concrete sprinkler cup to embed  
Fixatie voor instort sprinklercup in beton  
Fixation pour connexion sprinkler à encastrer en béton  
Fixierung für Sprinkler-Anschluss im Beton zum Eingiessen

Article number	Bag / Box	Type
SPR-FIXSCREW	60 pc. / 360	SCREW FIXATION
SPR-FIXGLUE	60 pc. / 360	GLUE FIXATION

## Type: SPR-ISO

NEW PRODUCT



Insulation for glue and screw fixation  
Isolatie voor lijm- en schroeffixatie  
Isolation pour fixation à coller et à visser.  
Isolierung für Fixierung zum Schrauben und Kleben

Article number	Bag	Type
SPR-ISO	60 pc.	PE



# Henco Sprinkler

Henco PRO-Sprinkler



## Type: SPR-N0604



Reduction 1" M- 1/2" F;  
different built-in depths for SPR-CBLOCK (L) and SPR-CBLOCK-WS (H)

Reductie 1" BuDr-1/2" BiDr;  
verschillende inbouwdieptes SPR-CBLOCK (L) en SPR-CBLOCK-WS (H)

Réduction 1" F-1/2" M;  
différentes profondeurs d'installation SPR-CBLOCK (L) et SPR-CBLOCK-WS (H)

Reduktion 1" IG-1/2" AG;  
unterschiedliche Einbautiefen SPR-CBLOCK (L) und SPR-CBLOCK-WS (H)

Article number	Box	Built-in depth sprinkler*
SPR-N0604IDLXXH00	56 pc.	L: --mm - H: 00mm
SPR-N0604IDLXXH05	60 pc.	L: --mm - H: 05mm
SPR-N0604IDLXXH10	63 pc.	L: --mm - H: 10mm
SPR-N0604IDL00H15	36 pc.	L: 00mm - H: 15mm
SPR-N0604IDL05H20	72 pc.	L: 05mm - H: 20mm
SPR-N0604IDL10H25	72 pc.	L: 10mm - H: 25mm
SPR-N0604IDL15H30	72 pc.	L: 15mm - H: 30mm
SPR-N0604IDL20H35	72 pc.	L: 20mm - H: 35mm
SPR-N0604IDL25H40	72 pc.	L: 25mm - H: 40mm
SPR-N0604IDL30H45	108 pc.	L: 30mm - H: 45mm

\*L: built-in depth for SPR-CBLOCK

H: built-in depth for SPR-CBLOCK-80-WS



## Type: SPR-PLUGTOOL

NEW PRODUCT



Tool to remove pressure test plug and mount reducer  
Tool voor verwijderen afpersplug en monteren verloopnippel  
Outil pour retirer bouchon et monter réduction  
Werkzeug zum Entfernen des Presseteststopfen und montieren Reduktion

Article number	Bag	Type
SPR-PLUGTOOL	10 pc.	Plugtool

## Type: SPR-PULLTOOL

NEW PRODUCT



Tool to remove fixation element  
Tool voor verwijderen fixatie element  
Outil pour retirer élément de fixation  
Werkzeug zum Entfernen des Fixierungselements

Article number	Box	Type
SPR-PULLTOOL	1 pc.	Pulltool

1

2

3

4

5

6

7

8

9

10

11

12

# CERTIFICATES - CERTIFICATEN - APPROBATIONS - ZERTIFIKATE





GERMANY



AUSTRIA



FRANCE



THE NETHERLANDS



POLAND



DENMARK



ITALY



RUSSIA



SLOVAKIA



ATG SYSTEM CERTIFICATE BELGIUM



NORWAY



FINLAND



HUNGARY



ENGLAND



SWEDEN



USA



ESTONIA



SPAIN



CZECH REPUBLIC



SOUTH AFRICA

# INDEX

Article number	Page	Article number	Page	Article number	Page	Article number	Page
1-1805	92	10PKG-261626	47	11PK-322626	31	12P-162016	75
1-2004-S	92	10PKG-262026	47	11PK-402032	31	12P-202620	75
1-2005-S	92	10PKG-321632	47	11PK-402632	31	12P-263226	75
1-2605-S	92	10PKG-322032	47	11PK-403232	31	12PK-161816	31
1-2606-S	92	10PKG-322632	47	11PK-404026	31	12PK-162016	31
1-3206-S	92	10PKG-401640	47	11PK-404032	31	12PK-202620	31
1-1804-S	92	10PKG-402040	47	11PK-502040	31	12PK-263226	31
1-2004-ZS	92	10PKG-402640	47	11PK-502640	31	12PK-324032	31
10-1604SN	93	10PKG-403240	47	11PK-503240	31	12PK-405040	31
10P-181618	74	10PKS-403240	164	11PK-504040	31	12PKG-162016	48
10P-201620	74	10PKS-503250	164	11PKG-201616	48	12PKG-202620	48
10P-261626	74	10PKS-504050	164	11PKG-202016	48	12PKG-263226	48
10P-262026	74	10PKS-633263	164	11PKG-261620	48	12PKG-324032	48
10P-321632	74	10PKS-634063	164	11PKG-262016	48	12PKS-324032	165
10P-322032	74	10PKS-635063	164	11PKG-262020	48	12PKS-405040	165
10P-322632	74	10PKW-201620	41	11PKG-262616	48	12PKW-162016	42
10PG-262026	88	10PKW-261626	41	11PKG-262620	48	12PKW-202620	42
10PK-161416	30	10PKW-262026	41	11PKG-322026	48	12PKW-263226	42
10PK-181418	30	10PKW-321632	41	11PKG-322626	48	12SK-162016	66
10PK-181618	30	10PKW-322032	41	11PKG-402032	48	12SK-202620	66
10PK-201420	30	10PKW-322632	41	11PKG-402632	48	13-1415-2	94
10PK-201620	30	10SK-201620	65	11PKG-403232	48	13-1615A-2	94
10PK-201820	30	10SK-261626	65	11PKG-404026	48	13-1615HA-2	94
10PK-261626	30	10SK-262026	65	11PKG-404032	48	13-2022HA-2	94
10PK-261826	30	11P-201616	74	11PKS-403232	164	13-2628H-2	94
10PK-262026	30	11P-202016	74	11PKS-404032	164	13-V2622H-2	94
10PK-321632	30	11P-261620	74	11PKS-503240	164	13P-160416	75
10PK-321832	30	11P-262020	74	11PKS-504040	164	13P-200420	75
10PK-322032	30	11P-262616	74	11PKW-261620	42	13P-200520	75
10PK-322632	30	11P-262620	74	11PKW-201616	42	13P-260426	75
10PK-401640	30	11P-322026	74	11PKW-202016	42	13P-260526	75
10PK-402040	30	11P-322626	74	11PKW-262016	42	13P-320532	75
10PK-402640	30	11PG-201616	88	11PKW-262020	42	13PG-200420	88
10PK-403240	30	11PK-161414	31	11PKW-262616	42	13PG-260426	88
10PK-502050	30	11PK-181616	31	11PKW-262620	42	13PK-160416BP	32
10PK-502650	30	11PK-201616	31	11PKW-322026	42	13PK-180418BP	32
10PK-503250	30	11PK-201818	31	11PKW-322626	42	13PK-200420BP	32
10PK-504050	30	11PK-202016	31	11SK-201616	66	13PK-200520	32
10PK-632663	30	11PK-261616	31	11SK-202016	66	13PK-260420BP	32
10PK-633263	30	11PK-261620	31	11SK-261620	66	13PK-260426BP	32
10PK-634063	30	11PK-262016	31	11SK-262016	66	13PK-260526	32
10PK-635063	30	11PK-262020	31	11SK-262020	66	13PK-320532	32
10PK-16JG1016	30	11PK-262616	31	11SK-262616	66	13PK-320632	32
10PK-20JG1020	30	11PK-262620	31	11SK-262620	66	13PK-320732	32
10PKG-201620	47	11PK-322026	31	12P-161816		13PK-400640	32



Article number	Page	Article number	Page	Article number	Page	Article number	Page
13PK-400740	32	13PKS-400740	165	14P-260426	75	15PG-2626	89
13PK-500850	32	13PKS-500850	165	14PK-160416	33	15PG-3232	89
13PK-631063	32	13PKS-631063	165	14PK-180418	33	15PK-1414	33
13PK-400540	32	13PKS-320432-N	165	14PK-200420	33	15PK-1616	33
13PK-500550	32	13PKS-320532-N	165	14PK-200520	33	15PK-1818	33
13PK-400640-N	32	13PKS-320632-N	165	14PK-260426	33	15PK-2020	33
13PK-400740-N	32	13PKS-320732-N	165	14PK-260526	33	15PK-2626	33
13PK-500850-N	32	13PKS-400440-N	165	14PK-260626	33	15PK-3232	33
13PK-631063-N	32	13PKS-400640-N	165	14PK-320532	33	15PK-4040	33
13PK-500550-N	32	13PKS-400740-N	165	14PK-400640	33	15PK-5050	33
13PK-160416-X	32	13PKS-500850-N	165	14PK-400740	33	15PK-6363	33
13PK-180418-X	32	13PKS-631063-N	165	14PK-500850	33	15PKG-1616	49
13PK-200420-X	32	13PKS-630463-N	165	14PK-631063	33	15PKG-2020	49
13PK-200520-X	32	13PKS-320632OP	169	14PK-400640-N	33	15PKG-2626	49
13PK-260420-X	32	13PKW-200520	42	14PK-400740-N	33	15PKG-3232	49
13PK-260426-X	32	13PKW-260526	42	14PK-500850-N	33	15PKG-4040	49
13PK-260526-X	32	13PKW-320532	42	14PK-631063-N	33	15PKS-3232	166
13PK-320532-X	32	13PKW-320632	42	14PKG-160416	49	15PKS-4040	166
13PK-320632-X	32	13PKW-160416	42	14PKG-200420	49	15PKS-5050	166
13PK-320732-X	32	13PKW-200420	42	14PKG-260426	49	15PKS-6363	166
13PK-400540-X	32	13PKW-260426	42	14PKG-260626	49	15SK-1616	67
13PK-400640-X	32	13PKW-160416-N	43	14PKS-320532	166	15SK-2020	67
13PK-400740-X	32	13PKW-200420-N	43	14PKS-400640	166	15SK-2626	67
13PK-500550-X	32	13PKW-200520-N	43	14PKS-400740	166	16HNBA	54
13PK-500850-X	32	13PKW-260426-N	43	14PKS-500850	166	16P-1816	76
13PK-631063-X	32	13PKW-260526-N	43	14PKS-631063	166	16P-2016	76
13PKG-160416BP	48	13PKW-320532-N	43	14PKS-320532-N	166	16P-2018	76
13PKG-200420BP	48	13PKW-320632-N	43	14PKS-400640-N	166	16P-2616	76
13PKG-200520	48	13PKW-160416-X	42	14PKS-400740-N	166	16P-2620	76
13PKG-260420BP	48	13PKW-200420-X	42	14PKS-500850-N	166	16P-3216	76
13PKG-260426BP	48	13PKW-200520-X	42	14PKS-631063-N	166	16P-3220	76
13PKG-260526	48	13PKW-260426-X	42	14PKW-160416-N	43	16P-3226	76
13PKG-320532	48	13PKW-260526-X	42	14PKW-200420-N	43	16PG-2016	89
13PKG-320632	48	13PKW-320532-X	42	14PKW-200520-N	43	16PG-2620	89
13PKG-320732	48	13PKW-320632-X	42	14SK-160416	66	16PG-3226	89
13PKG-400640	48	13SK-160416BP	66	14SK-200420	66	16PK-1614	34
13PKG-400740	48	13SK-200420BP	66	14SK-260426	66	16PK-1814	34
13PKS-260426		13SK-200520	66	15P-1616	75	16PK-1816	34
13PKS-320432	165	13SK-260420BP	66	15P-1818	75	16PK-2014	34
13PKS-320532	165	13SK-260426BP	66	15P-2020	75	16PK-2016	34
13PKS-320632	165	13SK-260526	66	15P-2626	75	16PK-2018	34
13PKS-320732	165	14P-160416	75	15P-3232	75	16PK-2616	34
13PKS-400440	165	14P-200420	75	15PG-1616	89	16PK-2618	34
13PKS-400640	165	14P-200520	75	15PG-2020	89	16PK-2620	34

# INDEX

Article number	Page	Article number	Page	Article number	Page	Article number	Page
16PK-3216	34	17P-3207	76	17PKS-4006-N	167	18P-1604	77
16PK-3220	34	17P-1604DZR	76	17PKS-4007-N	167	18P-1804	77
16PK-3226	34	17P-1605	76	17PKS-5008-N	167	18P-2004	77
16PK-4026	34	17PG-1604	89	17PKS-6310-N	167	18P-2005	77
16PK-4032	34	17PG-2004	89	17PKW-1604	44	18P-2605	77
16PK-5032	34	17PG-2005	89	17PKW-2004	44	18P-2606	77
16PK-5040	34	17PG-2605	89	17PKW-2005	44	18P-3206	77
16PK-6340	34	17PG-2606	89	17PKW-2605	44	18P-3207	77
16PK-6350	34	17PG-3206	89	17PKW-2606	44	18PG-1604	90
16PKG-2016	49	17PK-1404	34	17PKW-3206	44	18PG-2004	90
16PKG-2616	49	17PK-1604	34	17PKW-3207	44	18PG-2005	90
16PKG-2620	49	17PK-1804	34	17PKW-1604-N	44	18PG-2605	90
16PKG-3216	49	17PK-1805	34	17PKW-2004-N	44	18PG-2606	90
16PKG-3220	49	17PK-2004	34	17PKW-2005-N	44	18PG-3206	90
16PKG-3226	49	17PK-2005	34	17PKW-2605-N	44	18PK-1404	35
16PKG-4026	49	17PK-2605	34	17PKW-2606-N	44	18PK-1604	35
16PKG-4032	49	17PK-2606	34	17PKW-3206-N	44	18PK-1804	35
16PKS-4032	166	17PK-3206	34	17PKW-3207-N	44	18PK-1805	35
16PKS-5032	166	17PK-3207	34	17SK-1603	67	18PK-2004	35
16PKS-5040	166	17PK-4006	34	17SK-1604	67	18PK-2005	35
16PKS-6340	166	17PK-4007	34	17SK-2004	67	18PK-2605	35
16PKS-6350	166	17PK-5008	34	17SK-2005	67	18PK-2606	35
16PKW-2016	44	17PK-6310	34	17SK-2605	67	18PK-3206	35
16PKW-2620	44	17PK-4006-N	34	17SK-2606	67	18PK-3207	35
16PKW-3220	44	17PK-4007-N	34	17SKS-2004	68	18PK-4006	35
16PKW-3226	44	17PK-5008-N	34	17SKS-2005	68	18PK-4007	35
16PKW-2616	44	17PK-6310-N	34	17SKS-2604	68	18PK-5008	35
16PKW-3216	44	17PKG-1604	50	17SKS-2605	68	18PK-6310	35
16SK-2016	67	17PKG-2004	50	17SKS-2004	100	18PK-4006-N	36
16SK-2616	67	17PKG-2005	50	17SKS-2005	100	18PK-4007-N	36
16SK-2620	67	17PKG-2605	50	17SKS-2604	100	18PK-5008-N	36
17HNA-10	55	17PKG-2606	50	17SKS-2605	100	18PK-6310-N	36
17HNA-12	55	17PKG-3206	50	17VBS-2005	105	18PK-1604-X	35
17HNA-10-N	55-56	17PKG-3207	50	17VBS-2605	105	18PK-1804-X	35
17HNA-12-N	55	17PKG-4006	50	17VBS-2606	105	18PK-1805-X	35
17P-1603	76	17PKG-4007	50	18EK05-03	101	18PK-2004-X	35
17P-1604	76	17PKS-3206	167	18HNB-14	56	18PK-2005-X	35
17P-1804	76	17PKS-3207	167	18HNA-06	56	18PK-2605-X	35
17P-1805	76	17PKS-4006	167	18HNA-10	56	18PK-2606-X	35
17P-2004	76	17PKS-4007	167	18HNA-12	56	18PK-3206-X	35
17P-2005	76	17PKS-5008	167	18HNA-06-N	56	18PK-3207-X	35
17P-2605	76	17PKS-6310	167	18HNA-10-N	56	18PK-4006-X	35
17P-2606	76	17PKS-3206-N	167	18HNA-12-N	56	18PK-4007-X	35
17P-3206	76	17PKS-3207-N	167	18HNB-14-N	56	18PK-5008-X	35

Article number	Page	Article number	Page	Article number	Page	Article number	Page
18PK-6310-X	35	18SK-2005	67	1PK-16JG10	26	26PK-5008	36
18PKG-1604	50	18SK-2605	67	1PK-20JG10	26	26PK-6310	36
18PKG-2004	50	18SK-2606	67	1PKG-1616	46	26PKW-1605	45
18PKG-2005	50	18SKS-2004	68	1PKG-2020	46	26PKW-2005	45
18PKG-2605	50	18SKS-2005	68	1PKG-2626	46	26SK-1605	68
18PKG-2606	50	18SKS-2604	68	1PKG-3232	46	26SK-2005	68
18PKG-3206	50	18SKS-2605	68	1PKG-4040	46	26SK-1605	100
18PKG-3207	50	18SKS-2004	100	1PKS-3232	163	26SK-2005	100
18PKG-4006	50	18SKS-2005	100	1PKS-4040	163	27HNB	54
18PKG-4007	50	18SKS-2604	100	1PKS-5050	163	27HNA	54
18PKS-3207	167	18SKS-2605	100	1PKS-6363	163	27P-2626	79
18PKS-4006	167	19P-1605	77	1PKW-1616	38	27P-3232	79
18PKS-4007	167	19P-1805	77	1PKW-2020	38	27PK-4040	37
18PKS-5008	167	19P-2005	77	1PKW-2626	38	27PK-5050	37
18PKS-6310	167	19PK-1605	36	1PKW-3232	38	27PK-6363	37
18PKS-3207-N	167	19PK-2005	36	1SK-1616	64	27PK-2626	37
18PKS-4006-N	167	19PKW-1605	45	1SK-2020	64	27PK-3232	37
18PKS-4007-N	167	19PKW-2005	45	1SK-2626	64	27PKG-4040	50
18PKS-5008-N	167	19SK-1505	68	2-2020-S	92	27PKS-4040	168
18PKS-6310-N	167	19SK-1605	68	2-1616-S	92	27PKS-5050	168
18PKS-3206OP	169	19SK-2005	68	24-2022	94	27PKS-6363	168
18PKW-1604	44	19SK-1505	99	24-2622	94	27PKW-2626	45
18PKW-2004	44	19SK-1605	99	24P-1604	77	27PKW-3232	45
18PKW-2005	44	19SK-2005	99	24P-2004	77	28P-14041604-1	79
18PKW-2605	44	1HNB	54	25P-1604	77	28P-16041604-1	79
18PKW-2606	44	1HNA	54	26P-1604	78	28PF-16041604	79
18PKW-3206	44	1P-1616	72	26P-1605	78	28PF-20042004	79
18PKW-3207	44	1P-1818	72	26P-2004	78	28PK-04	37
18PKW-1604-N	45	1P-2020	72	26P-2005	78	28PV-16031603-1	79
18PKW-2004-N	45	1P-2626	72	26P-2605	78	28PV-16041604-1	79
18PKW-2005-N	45	1P-3232	72	26P-2606	78	29P-2622-CS	80
18PKW-2605-N	45	1PG-1616	86	26P-3206	78	29P-2022-CS	80
18PKW-2606-N	45	1PG-2020	86	26P-16Z05	78	29P-2018-CS	80
18PKW-3206-N	45	1PG-2626	86	26P-16Z03	78	2C-0404	97
18PKW-3207-N	45	1PG-3232	86	26P-16Z04	78	2P-1604	72
18PKW-1604-X	45	1PK-1414	26	26P-20Z05	78	2P-1804	72
18PKW-2004-X	45	1PK-1616	26	26P-26Z06	78	2P-2004	72
18PKW-2005-X	45	1PK-1818	26	26P-32Z06	78	2P-2005	72
18PKW-2605-X	45	1PK-2020	26	26P-32Z07	78	2P-2605	72
18PKW-2606-X	45	1PK-2626	26	26PK-1605	36	2P-1404K	72
18PKW-3206-X	45	1PK-3232	26	26PK-2005	36	2P-1604K	72
18PKW-3207-X	45	1PK-4040	26	26PK-4008	36	2PG-1604	86
18SK-1604	67	1PK-5050	26	26PK-5010	36	2PG-2004	86
18SK-2004	67	1PK-6363	26	26PK-6312	36	2PG-2005	86

# INDEX

Article number	Page	Article number	Page	Article number	Page	Article number	Page
2PG-2605	86	3-2004-S	92	3P-260426VK	72	52PS32	168
2PG-1604K	86	3-2005-S	92	3PK-160416BP	27	53PK40	37
2PK-1404BP	26	3-2605-S	92	3PK-200420BP	27	53PK50	37
2PK-1603	26	3-2606-S	92	3PK-160416-X	27	53PK63	37
2PK-1604BP	26	30P-1614S	80	3PK-200420-X	27	53PKS40	168
2PK-1804BP	26	30P-2022S	80	3PKW-160416	39	53PKS50	168
2PK-2004BP	26	30P-2622S	80	3PKW-200420	39	53PKS63	168
2PK-2005	26	30PG-2022S	90	3PKW-160416-N	40	120-PRT1620	21
2PK-2605	26	30PG-2622S	90	3PKW-200420-N	40	200-PRT1620	21
2PK-1604KBP	27	31P-161616	80	3PKW-160416-X	40	600-PRT1620	21
2PK-1604-X	26	31P-201616	80	3PKW-200420-X	40	600-PRT1720	21
2PK-1404-X	26	31P-201620	80	3SK-160416BP	64	600-PRT1820	21
2PK-1804-X	26	31P-202020	80	3SK-200420BP	64	600-PRT2020	21
2PK-2004-X	26	33P-1605	81	4-1616-S	92	240-PRT1820	21
2PK-2005-X	26	34P-1604	81	4-2020-S	92	600-PRT1420	21
2PK-2605-X	26	34P-3206	81	4-2626-S	92	200-PXC1620	20
2PKG-1603	46	34P-2004-CS	81	40P-1615S	82	600-PXC1620	20
2PKG-1604BP	46	34P-2005-CS	81	40P-2022S	82	200-PXC1720	20
2PKG-2004BP	46	34P-2605-CS	81	40P-2622S	82	240-PXC1820	20
2PKG-2005	46	35P-1615P	81	41P-16	83	200-PXC2020	20
2PKG-2605	46	35P-2022P	81	41P-20	83	600-PXC1720	20
2PKG-1604KBP	46	36P-1612P	82	41P-26	83	600-PXC2020	20
2PKW-2005	38	36P-1614P	82	41S-20	110	5P-1603	73
2PKW-2605	38	36P-1615P	82	41S-26	110	5P-1604	73
2PKW-1604	38	36P-1616P	82	41SKS-20	110	5P-1804	73
2PKW-2004	38	36P-2018P	82	41SKS-26	110	5P-2004	73
2PKW-1604K	39	36P-2022P	82	42P-161615	83	5P-2005	73
2PKW-1604K-N	39	36P-2622P	82	42P-202019	83	5P-2605	73
2PKW-1604K-X	39	36P-3228P	82	43P-161516	83	5P-3206	73
2PKW-1604-N	38	36P-2628P	82	44P-1604	84	5P-1604DZR	73
2PKW-2004-N	38	36PG-1615P	90	45P-1604	84	5PG-1604	87
2PKW-2005-N	38	36PG-2015P	90	4P-1604	73	5PG-2004	87
2PKW-2605-N	38	36PG-2022P	90	4P-2004	73	5PG-2005	87
2PKW-1604-X	38	36PG-2615P	90	5-1804	93	5PG-2605	87
2PKW-2004-X	38	36PG-2622P	90	5-1604-S	93	5PK-1404	28
2PKW-2005-X	38	37P-1412L	82	5-2005-S	93	5PK-1604	28
2PKW-2605-X	38	37P-1612L	82	5-2606-S	93	5PK-1804	28
2S-1604K	64	37P-1615L	82	50P-3206	168	5PK-2004	28
2SK-1604BP	64	39P-160450	82	50P-320604	168	5PK-2005	28
2SK-2004BP	64	3EK-050405	96	50P-320605	168	5PK-2605	28
2SK-2005	64	3P-160416	72	50P43-320604	168	5PK-3206	28
2SK-2605	64	3P-200420	72	52P20	84	5PK-4007	28
3-1604-S	92	3P-160416VK	72	52P26	84	5PK-5007	28
3-1804-S	92	3P-200420VK	72	52P32	84	5PK-5008	28

Article number	Page	Article number	Page	Article number	Page	Article number	Page
5PK-6310	28	6PG-2605	87	6PKS-4007-N	164	9PG-161616	87
5PK-4007-N	28	6PK-1404BP	28	6PKS-5004-N	164	9PG-202020	87
5PK-5007-N	28	6PK-1603	28	6PKS-5007-N	164	9PG-323232	87
5PK-5008-N	28	6PK-1604BP	28	6PKS-5008-N	164	9PK-141414	29
5PK-6310-N	28	6PK-1804BP	28	6PKW-1603	40	9PK-161616	29
5PKG-1604	46	6PK-2004BP	28	6PKW-2005	40	9PK-181818	29
5PKG-2004	46	6PK-2005	28	6PKW-2605	40	9PK-202020	29
5PKG-2005	46	6PK-2605	28	6PKW-3206	40	9PK-262626	29
5PKG-2605	46	6PK-3206	28	6PKW-1603-N	41	9PK-323232	29
5PKG-3206	46	6PK-4007	28	6PKW-1604-N	41	9PK-404040	29
5PKG-4007	46	6PK-5007	28	6PKW-2004-N	41	9PK-505050	29
5PKS-3206	163	6PK-5008	28	6PKW-2005-N	41	9PK-636363	29
5PKS-4007	163	6PK-6310	28	6PKW-2605-N	41	9PKG-161616	47
5PKS-5008	163	6PK-4007-N	29	6PKW-3206-N	41	9PKG-202020	47
5PKS-6310	163	6PK-5007-N	29	6PKW-1604-X	41	9PKG-262626	47
5PKS-5007	163	6PK-5008-N	29	6PKW-2004-X	41	9PKG-323232	47
5PKS-3206-N	163	6PK-6310-N	29	6PKW-2005-X	41	9PKG-404040	47
5PKS-5008-N	163	6PK-1404-X	29	6PKW-2605-X	41	9PKS-323232	164
5PKS-6310-N	163	6PK-1604-X	29	6PKW-3206-X	41	9PKS-404040	164
5PKW-1604	40	6PK-1804-X	29	6SK-1604BP	65	9PKS-505050	164
5PKW-2004	40	6PK-2004-X	29	6SK-2004BP	65	9PKS-636363	164
5PKW-2005	40	6PK-2005-X	29	6SK-2005	65	9PKW-161616	41
5PKW-2605	40	6PK-2605-X	29	6SK-2605	65	9PKW-202020	41
5PKW-3206	40	6PK-3206-X	29	6VBS-2005	105	9PKW-262626	41
5PKW-1604-N	40	6PK-4007-X	29	6VBS-2605	105	9PKW-323232	41
5PKW-2004-N	40	6PK-5007-X	29	7-1604-S	93	9SK-161616	65
5PKW-2005-N	40	6PK-5008-X	29	7P-1605	74	9SK-202020	65
5PKW-2605-N	40	6PK-6310-X	29	7P-1605K	74	9SK-262626	65
5PKW-3206-N	40	6PKG-1604BP	47	7P-1605L	74	AB1420	95
5SK-1604	65	6PKG-2004BP	47	8-161616-S	93	ABEK04	95
5SK-2004	65	6PKG-2005	47	8HNB-PK90	54	AD-EKEK	96
5SK-2005	65	6PKG-2605	47	8HNA-PK40	54	AK-EK05VD	160
5SK-2605	65	6PKG-3206	47	8HNA-PK50	54	AN1420	96
6-1804	93	6PKG-4007	47	8HNA-PK63	54	AT1420	96
6-1604-S	93	6PKS-3206	163	8HNA-PK75	54	BA-1288	138
6-2005-S	93	6PKS-4004	163	8HNA-PK32	54	BA-1410	138
6P-1604	73	6PKS-4007	163	8P-1604	74	BA-1612	138
6P-1804	73	6PKS-5004	163	9HNB	54	BA-1814	138
6P-2004	73	6PKS-5007	163	9HNA	54	BA-2016	138
6P-2005	73	6PKS-5008	163	9P-161616	74	BA-F41	110
6P-2605	73	6PKS-6304	163	9P-181818	74	BAP-FFV1616	109
6PG-1604	87	6PKS-6310	163	9P-202020	74	BAP-FFV2020	109
6PG-2004	87	6PKS-3206-N	164	9P-262626	74	BAP-FFV2626	109
6PG-2005	87	6PKS-4004-N	164	9P-323232	74	BAP-FFV3232	109

# INDEX

Article number	Page	Article number	Page	Article number	Page	Article number	Page
BAP-FFV1604	109	BE28HC	147	BM-16F	139	CU-ACT-B230V	131
BAP-FFV1805	109	BE15HM	147	BM-20F	139	CU-ACT-B230V	134
BAP-FFV2005	109	BE22HM	147	BP04	27	CU-ANTRF	134
BAP-FFV2605	109	BE18HM	147	10-160212-KB	7	CU-ATHERMB-H	130
BAP-FFV2606	109	BE14M	152	25-160212-KB	7	CU-ATHERMB-HC	130
BAP-FFV3207	109	BE16M	152	25-200216-KB	7	CU-ATHERMRF-HC	133
BAP-FFV1605EK	109	BE18M	152	50-260320-GAS	23	CU-DTHERMB-HC	131
BAP-FFV2005EK	109	BE20M	152	50-320326-GAS	23	CU-DTHERMRF-HC	133
BAP-FFV2605EK	109	BE-MINI	151	100-R180214	14	CU-RADTHERMRF	134
BAP-FFV16Z05	109	BE-MINI3	150	200-R180214	14	CU-REPRF	134
BAP-FFV26Z05	109	BE-UNI	146	50-R160212	14	CU-WIFIRF	134
BAP-FFV32Z06	109	BE-UNISSET1	145	100-R160212	14	CU-WIFIRFCABLE	134
BAP-H1616	110	BE-UNISSET2	145	200-R160212	14	CU-ZONERF-HC	133
BAP-H2020	110	BE-UNISSETMINI3	146	100-R200216	14	DRILLY14	153
BAP-H2626	110	BE16MINI	151	50-R260320	14	DRILLY16	153
BAP-H3232	110	BE20MINI	151	500-R160212D	14	DRILLY20	153
BAP-SV1610S	110	BE26MINI	151	10-R160212-KB	14	DRILLY26	153
BCLIP-16	158	BE32MINI	151	15-R160212-KB	14	DRILLY32	153
BCLIP-1820	158	BE16MINI3	150	25-R160212-KB	14	EK16-2	94
BCLIP-26	158	BE20MINI3	150	50-320326-SPR	24	EK14-2	94
BCLIP-32	158	BE26MINI3	150	50-320326-SPR	162	EK17-2	94
BCLIP-40	158	BE32MINI3	150	100-121688	7	EK20-2	94
BCLIP-50	158	BE15MMINI	151	200-121688	7	EK15	95
BDR33M	160	BE22MMINI	151	100-140210	7	EK15	111
BDB33M	160	BE12M-MINI3	150	200-140210	7	ENDCAP-EK05	102
BE32	145	BE15M-MINI3	150	50-160212	7	5-FLEX32	13
BE40	145	BE18M-MINI3	150	100-160212	7	10-FLEX32	13
BE50	145	BE22M-MINI3	150	200-160212	7	15-FLEX32	13
BE63	145	BE28M-MINI3	150	100-180214	7	100-F16R-WZ	19
BE16	145	BE15V-MINI3	150	200-180214	7	200-F16R-WZ	19
BE26	145	BE18V-MINI3	150	25-200216	7	100-F20R-WZ	19
BE-BOX	147	BE22V-MINI3	150	50-200216	7	400-F20R-WZ	19
BE15C	151	BE28V-MINI3	150	100-200216	7	500-F16R-WZ	19
BE18C	151	BI-1410	138	50-260320	7	25-016GASMG	23
BE22C	151	BI-1612	138	50-320326	7	50-016GASMG	23
BE28C	151	BI-1612L	138	500-160212D	7	25-020GASMG	23
BE14H	147	BI-1814	138	50-ISO4-COMBI16R	18	50-020GASMG	23
BE16H	147	BI-2016	138	50-COMBI16R	18	50-026GASMG	23
BE18H	147	BI-2016L	138	50-COMBI16	12	25-032GASMG	23
BE20H	147	BI-2620	138	CU-10ZONERF-HC	133	25-026GASMG	23
BE26H	147	BM-16	139	CU-6ZONE-CON	130	H-0212	107
BE32H	147	BM-20	139	CU-6ZONEB-H	130	H-0212-S	107
BE12HC	147	BM-26	139	CU-6ZONEB-HC	130	HFMAN125	160
BE22HC	147	BM-18	139	CU-6ZONERF-HC	133	HNA	55

Article number	Page	Article number	Page	Article number	Page	Article number	Page
HNB	55	12PK-639063	60	IM63	140	25-ISO20-32-BL-BSD	11
1PK-7575	58	12PK-759075	60	IMEM63	140	25-ISO20-32-RO-BSD	11
1PK-9090	58	13PK-750675	60	IMEM1426-PRESS	139	50-ISO20-R16-BL-BSD	17
10PK-753275	59	13PK-751075	60	IM1426PRESS	139	50-ISO20-R16-RO-BSD	17
10PK-754075	59	13PK-751275	60	IM1426PRESS-N	139	50-ISO20-R20-BL-BSD	17
10PK-755075	59	13PK-901490	60	ISO-BLOCK-S	13	50-ISO20-R20-RO-BSD	17
10PK-756375	59	14PK-751075	60	ISO-BOX	80	25-ISO20-R26-BL-BSD	17
10PK-903290	59	14PK-751275	60	50-ISO13-16-BL	10	25-ISO20-R26-RO-BSD	17
10PK-904090	59	15PK-9090	60	50-ISO13-18-BL	10	100-ISO4-14-RO	8
10PK-905090	59	16PK-7532	61	50-ISO13-20-BL	10	100-ISO4-14-BL	8
10PK-906390	59	16PK-7540	61	50-ISO13-26-BL	10	100-ISO4-16-RO	8
10PK-907590	59	16PK-7550	61	25-ISO13-32-BL	10	100-ISO4-16-BL	8
11PK-753232	59	16PK-7563	61	50-ISO13-16-RO	10	50-ISO4-18-RO	8
11PK-753240	59	16PK-9032	61	50-ISO13-20-RO	10	50-ISO4-18-BL	8
11PK-753250	59	16PK-9040	61	50-ISO13-26-RO	10	50-ISO4-20-RO	8
11PK-753263	59	16PK-9050	61	25-ISO13-32-RO	10	50-ISO4-20-BL	8
11PK-754040	59	16PK-9063	61	50-ISO13-R16-BL	16	25-ISO4-26-RO	8
11PK-754050	59	16PK-9075	61	50-ISO13-R20-BL	16	25-ISO4-26-BL	8
11PK-754063	59	17PK-7510	61	50-ISO13-R26-BL	16	50-ISO4-26-RO	8
11PK-755050	59	17PK-7512	61	50-ISO13-R16-RO	16	50-ISO4-26-BL	8
11PK-755063	59	18PK-7506	61	50-ISO13-R20-RO	16	25-ISO4-32-RO	8
11PK-756363	59	18PK-7510	61	50-ISO13-R26-RO	16	25-ISO4-32-BL	8
11PK-903232	59	18PK-7512	61	50-ISO13-16-BL-BSD	11	50-ISO4-16-RO	8
11PK-903240	59	18PK-9014	61	50-ISO13-16-RO-BSD	11	50-ISO4-16-BL	8
11PK-903250	59	27PK-7575	61	50-ISO13-18-BL-BSD	11	50-ISO4-32-RO	8
11PK-903263	59	27PK-9090	61	50-ISO13-18-RO-BSD	11	50-ISO4-32-BL	8
11PK-903275	59	5PK-7510	58	50-ISO13-20-BL-BSD	11	100-ISO4-20-RO	8
11PK-904040	59	5PK-7512	58	50-ISO13-20-RO-BSD	11	100-ISO4-20-BL	8
11PK-904050	59	6PK-7506	58	50-ISO13-26-BL-BSD	11	50-ISO4-R18-RO	15
11PK-904063	59	6PK-7510	58	50-ISO13-26-RO-BSD	11	50-ISO4-R18-BL	15
11PK-904075	59	6PK-7512	58	25-ISO13-32-BL-BSD	11	100-ISO4-R16-RO	15
11PK-905050	59	6PK-9014	58	25-ISO13-32-RO-BSD	11	100-ISO4-R16-BL	15
11PK-905063	59	9PK-757575	58	50-ISO13-R16-BL-BSD	17	50-ISO4-R20-RO	15
11PK-905075	59	9PK-909090	58	50-ISO13-R16-RO-BSD	17	50-ISO4-R20-BL	15
11PK-906363	59	HNA-COMP	57	50-ISO13-R20-BL-BSD	17	25-ISO4-R26-RO	15
11PK-906375	59	HNAFL-DN50	57	50-ISO13-R20-RO-BSD	17	25-ISO4-R26-BL	15
11PK-907575	59	HN-PEN	55	50-ISO13-R26-BL-BSD	17	50-ISO4-R26-RO	15
12PK-327532	60	HNA-STOP	56	50-ISO13-R26-RO-BSD	17	50-ISO4-R26-BL	15
12PK-329032	60	HNB-STOP	56	50-ISO20-R16-RO	17	50-ISO4-R16-BL	15
12PK-407540	60	HNA-STOP-E	56-57	50-ISO20-R16-BL	17	50-ISO4-R16-RO	15
12PK-409040	60	HNA-U	55	50-ISO20-R20-RO	17	100-ISO4-14-BL-BSD	9
12PK-507550	60	HNB-U	55	50-ISO20-R20-BL	17	100-ISO4-14-RO-BSD	9
12PK-509050	60	HNA-EK05	57	25-ISO20-R26-RO	17	100-ISO4-16-BL-BSD	9
12PK-637563	60	HNTOOLSET	153	25-ISO20-R26-BL	17	100-ISO4-16-RO-BSD	9

# INDEX

Article number	Page	Article number	Page	Article number	Page	Article number	Page
50-ISO4-16-BL-BSD	9	50-ISO9-32-RO	10	KS16M	141	PLF-P-PK	159
50-ISO4-16-RO-BSD	9	50-ISO9-32-BL	10	KS18M	141	PLP-P-PK	159
50-ISO4-18-BL-BSD	9	50-ISO9-R16-RO	16	KS26M	141	PLUG04-B80	153
50-ISO4-18-RO-BSD	9	50-ISO9-R16-BL	16	KS-MSET1	141	PLUG04-R80	153
100-ISO4-20-BL-BSD	9	50-ISO9-R20-RO	16	KS-MSET4	141	PLUG05-B80	153
100-ISO4-20-RO-BSD	9	50-ISO9-R20-BL	16	KS-P162026	142	PLUG05-R80	153
50-ISO4-20-BL-BSD	9	25-ISO9-R26-RO	16	LB50	13	PRESSCHECK1432	153
50-ISO4-20-RO-BSD	9	25-ISO9-R26-BL	16	M-BA03	143	100-MR	22
50-ISO4-26-BL-BSD	9	50-ISO9-R26-BL	16	M-BAT03	143	100-MB	22
50-ISO4-26-RO-BSD	9	50-ISO9-R26-RO	16	M-BATMINI2	151	50-MR20	22
25-ISO4-26-BL-BSD	9	50-ISO9-14-BL-BSD	10	M-BATMINI3-2.0AH	149	50-MB20	22
25-ISO4-26-RO-BSD	9	50-ISO9-14-RO-BSD	10	M-BATMINI3-5.0AH	149	50-MR26	22
50-ISO4-32-BL-BSD	9	50-ISO9-16-BL-BSD	10	M-BH162026	152	50-MB26	22
50-ISO4-32-RO-BSD	9	50-ISO9-16-RO-BSD	10	M-BHY	144	25-MR32	22
25-ISO4-32-BL-BSD	9	50-ISO9-18-BL-BSD	10	M-BHY162026	144	25-MB32	22
25-ISO4-32-RO-BSD	9	50-ISO9-18-RO-BSD	10	M-BM1620	152	100-MBLACK	22
100-ISO4-R16-BL-BSD	15	50-ISO9-20-BL-BSD	10	M-BMINI3	148	50-MBLACK20	22
100-ISO4-R16-RO-BSD	15	50-ISO9-20-RO-BSD	10	M-BMINI3-F	148	50-MBLACK26	22
50-ISO4-R16-BL-BSD	15	50-ISO9-26-BL-BSD	10	M-BMINI3-S	148	50-MG16	22
50-ISO4-R16-RO-BSD	15	50-ISO9-26-RO-BSD	10	M-BOXBA03	143	100-MG16	22
25-ISO4-R16-BL-BSD	15	25-ISO9-26-BL-BSD	10	M-BOXBHY	145	50-MG20	22
25-ISO4-R16-RO-BSD	15	25-ISO9-26-RO-BSD	10	M-BOXMINI3	149	50-MG26	22
50-ISO4-R18-BL-BSD	15	50-ISO9-32-BL-BSD	10	M-BOXMINI3-F	149	25-MG32	22
50-ISO4-R18-RO-BSD	15	50-ISO9-32-RO-BSD	10	M-HP32	152	PS-16	138
50-ISO4-R20-BL-BSD	15	25-ISO9-32-BL-BSD	10	M-LAD03	144	PS-20	138
50-ISO4-R20-RO-BSD	15	25-ISO9-32-RO-BSD	10	M-LADMINI3	149	RAD04-100V	111
50-ISO4-R26-BL-BSD	15	50-ISO9-R16-BL-BSD	16	M-TRANS03	144	RADNI-0504	111
50-ISO4-R26-RO-BSD	15	50-ISO9-R16-RO-BSD	16	M-TRANSMINI3	149	RADTH-VL	111
25-ISO4-R26-BL-BSD	15	50-ISO9-R20-BL-BSD	16	N04	78	50-R18MR	18
25-ISO4-R26-RO-BSD	15	50-ISO9-R20-RO-BSD	16	N05	78	50-R18MB	18
50-ISO9-14-RO	9	50-ISO9-R26-BL-BSD	16	N06	78	25-R16MR	18
50-ISO9-14-BL	9	50-ISO9-R26-RO-BSD	16	P-PIESTOP16	85	25-R16MB	18
50-ISO9-16-RO	9	25-ISO9-R26-BL-BSD	16	P-PIESTOP20	85	50-R16MR	18
50-ISO9-16-BL	9	25-ISO9-R26-RO-BSD	16	P-PIESTOP26	85	50-R16MB	18
50-ISO9-18-RO	9	JCLIP-1632	158	P-PIESTOP32	85	50-R16MBLACK	18
50-ISO9-18-BL	9	JCLIP-1632D	158	PH-1632	140	100-R16MR	18
50-ISO9-20-RO	9	JCLIP-1632DL	158	PIPEPLUG16	159	100-R16MB	18
50-ISO9-20-BL	10	JCLIP-1632L	158	PIPEPLUG20	159	100-R16MBLACK	18
25-ISO9-26-RO	10	KS50	141	PIPEPLUG26	159	25-R20MR	18
25-ISO9-26-BL	10	KS63	141	PK-TOOL04	154	25-R20MB	18
50-ISO9-26-RO	10	KS-K	142	PK-TOOL05	154	25-R20MBLACK	18
50-ISO9-26-BL	10	KS32M	141	PK-TOOL06	154	50-R20MR	18
25-ISO9-32-RO	10	KS40M	141	PK-TOOLBOX	154	50-R20MB	18
25-ISO9-32-BL	10	KS14M	141	PK-TOOLBOX-040506	154	100-R20MR	18



Article number	Page	Article number	Page	Article number	Page	Article number	Page
100-R20MB	18	SPR-PULLTOOL	173	04-320326	8	UFH-060505-MD	124
50-R26MR	18	25-016MB-KB	13	05-320326	8	UFH-060506-MD	124
50-R26MB	18	25-016MR-KB	13	03-403533	8	UFH-060507-MD	124
RS32	140	50-014MR	12	04-403533	8	UFH-060508-MD	124
RSEM1420-PERS	140	50-014MB	12	05-403533	8	UFH-060509-MD	124
RSEM2640-PERS	140	25-016MR	12	03-504042	8	UFH-060510-MD	124
SAFECUT	138	25-016MB	12	04-504042	8	UFH-060511-MD	124
SK-B05	70	50-016MR	12	05-504042	8	UFH-060512-MD	124
SK-B05	103	50-016MB	12	02-634554		UFH-ADN10	119
SK-B05	106	50-016MBLACK	12	03-634554	8	UFH-AO03-MZ	126
SK-PIPESTOP16	69	100-016MR	12	04-634554	8	UFH-B0606-M	126
SK-PIPESTOP20	69	100-016MB	12	05-634554	8	UFH-B0606-VN	127
SK-PIPESTOP26	69	100-016MBLACK	12	05-756063	8	UFH-BEND1218	119
SK-STOPCLIP16	69	50-018MR	12	05-907076	8	UFH-BEND20	119
SK-STOPCLIP20	69	50-018MB	12	05-160212-GAS	23	UFH-B0605-VN	127
SK-STOPCLIP26	69	100-018MR	12	05-200216-GAS	23	UFH-BM0606-VN	127
SK-STOPCLIP16	102	100-018MB	12	05-260320-GAS	23	UFH-BMH0606-VN	127
SK-STOPCLIP20	102	25-020MR	12	05-320326-GAS	23	UFH-BMH0606T-VN	127
SK-STOPCLIP26	102	25-020MB	12	05-403533-GAS	23	UFH-BS05-M	126
SPLIT-S16	95	25-020MBLACK	12	03-R160212	14	UFH-BTM0606-M	125
SPLIT-S20	95	50-020MR	12	04-R160212	14	UFH-C191800	128
SPR-CBLOCK	170	50-020MB	12	05-R160212	14	UFH-C191974	128
SPR-CBLOCK80	170	50-020MBLACK	12	03-R200216	14	UFH-C191976	128
SPR-CBLOCK-TF	170	100-020MB	12	04-R200216	14	UFH-C192071	128
SPR-CBLOCK80-WS	170	100-020MR	12	05-R200216	14	UFH-C260003001	127
SPR-FIXSCREW	171	25-026MR	12	03-R260320	14	UFH-CAB-I1000	136
SPR-FIXGLUE	171	25-026MB	12	04-R260320	14	UFH-CAB-I400	136
SPR-ISO	171	50-026MR	12	05-R260320	14	UFH-CAB-I600	136
SPR-ISO-MAGNET26	171	50-026MB	12	05-634554-SPR	24	UFH-CAB-I800	136
SPR-ISO-WS	170	50-026MBLACK	12	05-504042-SPR	24	UFH-CAB-I565	136
SPR-MAGNET26	171	25-032MR	12	05-403533-SPR	24	UFH-CAB-I715	136
SPR-MAGNET31	171	25-032MB	12	05-320326-SPR	24	UFH-CAB-I965	136
SPR-N0604IDLXXH00	172	03-160212	8	05-634554-SPR	162	UFH-CAB-O1000	136
SPR-N0604IDLXXH05	172	04-160212	8	TESTPLUG16	159	UFH-CAB-O600	136
SPR-N0604IDLXXH10	172	05-160212	8	TESTPLUG20	159	UFH-CAB-O800	136
SPR-N0604IDL00H15	172	03-180214	8	TESTPLUG26	159	UFH-CAB-O615	136
SPR-N0604IDL05H20	172	05-180214	8	TESTPLUG16-RO	159	UFH-CAB-O1015	136
SPR-N0604IDL10H25	172	03-200216	8	TESTPLUG20-RO	159	UFH-CAB-O385Z	136
SPR-N0604IDL15H30	172	04-200216	8	TESTPLUG26-RO	159	UFH-CAB-O615Z	136
SPR-N0604IDL20H35	172	05-200216	8	TOOLBOX16202632	146	UFH-CAB-O1015Z	136
SPR-N0604IDL25H40	172	03-260320	8	TOOLBOX405063	146	UFH-0605CD01	120
SPR-N0604IDL30H45	172	04-260320	8	UFH-060502-MD	124	UFH-0605CD02	120
SPR-OP06	170	05-260320	8	UFH-060503-MD	124	UFH-0605CD03	120
SPR-PLUGTOOL	173	03-320326	8	UFH-060504-MD	124	UFH-0605CD04	120

# INDEX

Article number	Page	Article number	Page	Article number	Page	Article number	Page
UFH-0605CD05	120	UFH-DRY-1625-200F	115	UFH-0605MDK07-03LPRM	122	UFH-SCOTCH-66	114
UFH-0605CD06	120	UFH-DRY-1630-150F	115	UFH-0605MDK08-03LPRM	122	UFH-0405SLT01	121
UFH-0605CD07	120	UFH-DRY-FTAPE	115	UFH-0605MDK09-03LPRM	122	UFH-0405SLT02	121
UFH-0605CD08	120	UFH-DRY-GLUEF	115	UFH-0605MDK10-03LPRM	122	UFH-0405SLT03	121
UFH-0605CD09	120	UFH-DRY-GP100/2	116	UFH-0605MDK11-03LPRM	122	UFH-0405SLT04	121
UFH-0605CD10	120	UFH-DRY-VD100	116	UFH-0605MDK12-03LPRM	122	UFH-0405SLT05	121
UFH-0605CD11	120	UFH-ESK060303-M	126	UFH-0605MDSS02	123	UFH-0405SLT06	121
UFH-0605CD12	120	UFH-ESK060303-VN	126	UFH-0605MDSS03	123	UFH-0505SLT07	121
UFH-0605CD13	120	UFH-FOIL50	117	UFH-0605MDSS04	123	UFH-0505SLT08	121
UFH-0605CD14	120	UFH-FOIL90	117	UFH-0605MDSS05	123	UFH-0505SLT09	121
UFH-0605CD15	120	UFH-FOIL-ALU	117	UFH-0605MDSS06	123	UFH-0505SLT10	121
UFH-0605CD16	120	UFH-FOIL-CLIP25	117	UFH-0605MDSS07	123	UFH-0505SLT11	121
UFH-0605CD17	120	UFH-FOIL-N	117	UFH-0605MDSS08	123	UFH-0505SLT12	121
UFH-0605CD18	120	UFH-GKT	125	UFH-0605MDSS09	123	UFH-0505SLT14	121
UFH-0605CD19	120	UFH-ISOBOARD-GV	118	UFH-0605MDSS10	123	UFH-0505SLT15	121
UFH-0605CD20	120	UFH-ISOBOARD-GVNL	118	UFH-0605MDSS11	123	UFH-0505SLT16	121
UFH-0405CDP01	120	UFH-ISOBOARD-S	118	UFH-0605MDSS12	123	UFH-0405SSTE02-PN6	121
UFH-0405CDP02	120	UFH-ISODRY-25	116	UFH-0605MDSS13	123	UFH-0405SSTE03-PN6	121
UFH-0405CDP03	120	UFH-ISOPRO11	113	UFH-0605MDSS14	123	UFH-0405SSTE04-PN6	121
UFH-0405CDP04	120	UFH-ISOPRO30	113	UFH-0605MDSS15	123	UFH-0405SSTE06-PN6	121
UFH-0405CDP05	120	UFH-M-D	124	UFH-P18-GP10	116	UFH-0505SSTE07-PN6	121
UFH-0405CDP06	120	UFH-0605MDK02-03L	122	UFH-P18-GP18	115	UFH-0505SSTE08-PN6	121
UFH-0505CDP07	120	UFH-0605MDK03-03L	122	UFH-P18-GP18V	115	UFH-0505SSTE09-PN6	121
UFH-0505CDP08	120	UFH-0605MDK04-03L	122	UFH-P18-WN	116	UFH-0505SSTE10-PN6	121
UFH-0505CDP09	120	UFH-0605MDK05-03L	122	UFH-PGKTA	125	UFH-0505SSTE11-PN6	121
UFH-0505CDP10	120	UFH-0605MDK06-03L	122	UFH-PGKTA-TH	125	UFH-0505SSTE12-PN6	121
UFH-0505CDP11	120	UFH-0605MDK07-03L	122	UFH-PLUG80	118	UFH-TACK	155
UFH-0505CDP12	120	UFH-0605MDK08-03L	122	UFH-PRO	113	UFH-TACK-38K	114
UFH-0505CDP13	120	UFH-0605MDK09-03L	122	UFH-RAS10	113	UFH-TACK-40	114
UFH-0505CDP14	120	UFH-0605MDK10-03L	122	UFH-RAS15	113	UFH-TACK-60	114
UFH-0505CDP15	120	UFH-0605MDK11-03L	122	UFH-RAS20	113	UFH-TACK-KLS20	114
UFH-0505CDP16	120	UFH-0605MDK12-03L	122	UFH-RAS-BIND15A	113	UFH-TACK-KLS25	114
UFH-CMDK03	124	UFH-MDK-AO	124	UFH-RAS-BIND15B	113	UFH-TACK-KLS30	114
UFH-CMDK10	124	UFH-MDK-CON	124	UFH-RAS-CLIP16	114	UFH-TM050-M	126
UFH-CMDSS03	125	UFH-0605MDK02-03LPRM	122	UFH-RAS-CLIP18	114	UFH-UP-12	117
UFH-CP	120	UFH-0605MDK03-03LPRM	122	UFH-RAS-CLIP20	114	UFH-UP-16	117
UFH-DH40	119	UFH-0605MDK04-03LPRM	122	UFH-RAS-CUT	156	UFH-UP-CUP50	117
UFH-DH40-BLACK		UFH-0605MDK05-03LPRM	122	UFH-RAS-RB3	113	UFH-UP-14M1	116
UFH-DP200	118	UFH-0605MDK06-03LPRM	122	UFH-RAS-VLE	156	UFH-UP-16M1	116
UFH-DRY-B						UFH-VLA	155
UFH-DRY-1617-150F	115					UFH-VLA-STR	155
UFH-DRY-1617-200F	115					V-050404-Z	106
UFH-DRY-1625-100F	115					V-060402	106
UFH-DRY-1625-150F	115					V-060404	106

Article number	Page	Article number	Page
V-060405	106	VEK-060507-Z	106
V-060406	106	VEK-060508-Z	106
VB-EK05	104	VEK-060509-Z	106
VB-HANDLE-RED	104	VEK-060510-Z	106
VB-HANDLE-BLUE	104	VISION-KEY16	69
VB050502-BLAUW	104	VISION-KEY20	69
VB050502-ROOD	104	VISION-KEY26	69
VB050503-BLAUW	104	VISION SET 16	69
VB050503-ROOD	104	VISION SET 20	69
VB050504-BLAUW	104	VISION SET 26	69
VB050504-ROOD	104	VB-EK05	110
VB060502-BLAUW	104	VS-05	107
VB060502-ROOD	104	VS-0504	107
VB060503-BLAUW	104	VS-0604	107
VB060503-ROOD	104	VS-0605	107
VB060504-BLAUW	104	VS-ENDCAP	101
VB060504-ROOD	104	VS-ENDCAP-M	102
VBS-05	104	VSK-1616	70
VBS-06	104	VSK-161616	70
VBS-05F	105	VSKEK-0502	99
VBS-06F	105	VVPK-20	103
VBS050502-BL	105	VVPK-26	103
VBS050502-RO	105	VVPK90-20-D	103
VBS050503-BL	105	VVPK90-26-D	103
VBS050503-RO	105	VVPK90-20-U	103
VBS050504-BL	105	VVPK90-26-U	103
VBS050504-RO	105	VVSK-20	100
VBS060502-BL	105	VVSK-26	100
VBS060503-RO	105	VVSK-20-90	101
VBS060503-BL	105	VVSK-26-90	101
VBS060504-RO	105	VVSK-T202020	101
VDEK-T05	101	VVSK-T262626	101
VDSK-20	102	VVSK-T26M26	100
VDSK-26	102	VVSK-T20M20	100
VEK-060502	106	WBP-1604-BL	85
VEK-060503	106	WBP-1604-RO	85
VEK-060504	106	WBP-2004-BL	85
VEK-060505	106	WBP-2004-RO	85
VEK-060507	106	WBPL-X	85
VEK-060508	106	WBPL-X	97
VEK-060503-Z	106	WBS-1604-RO	96
VEK-060504-Z	106	WBS-1604-BL	96
VEK-060505-Z	106		
VEK-060506-Z	106		



# We care to connect



## MyHenco

The best of Henco always at hand.



Register now  
for free.